

Section 8

Flanges

This section contains extracts from American and British specifications applicable to stainless steel flanges.

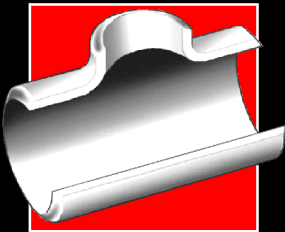

Subsections and topics	Pages
Flanges - General Information	8-2
ASME/ANSI Flanges (incl. MSS SP-44 and API 605)	8-4
Weld Neck Flanges - Welding Ends (ASME/ANSI)	8-5
Ring Joint Facings - ASME/ANSI B16.5 & B16.47	8-6
Weld Neck Flanges - ANSI B16.5	8-10, 8-46
Slip On Flanges - ANSI B16.5	8-17
Blind Flanges - ANSI B16.5 & ASME B16.47 (MSS SP-44)	8-24, 8-46
Lap Joint Flanges - ANSI B16.5	8-32
Threaded Flanges - ANSI B16.5	8-39
BS 3293 Flanges (Weld Neck and Slip On > NPS 26)	8-55
BS 4504 Circular Flanges - General	8-60
Weld Neck Flange - Welding Ends	8-62
Flange Facings - BS 4504	8-62
Flange Drilling Details - BS 4504	8-64
Plate Flanges (Code 101) - BS 4504	8-65
Weld Neck Flanges (Code 111) - BS 4504	8-66
Slip On Flanges (Code 112) - BS 4504	8-68
Threaded Flanges (Code 113) - BS 4504	8-69
Blank Flanges (Code 105) - BS 4504	8-70
BS 10 Flanges	8-71
Pressure/Temperature Ratings (ASME/ANSI)	8-73

Specifications covered in this Section	Page
ASME B16.5-1996 - Pipe Flanges and Flanged Fittings NPS 1/2 through NP 24	8-4 (general) 8-10 to 8-45
ASME B16.47-1996 - Large Diameter Steel Flanges NPS 26 through NPS 60 (Covers MSS SP-44 and API 605 flanges)	8-4 (general) 8-46 to 8-54
MSS SP-44 1996 - Edition, Steel Pipeline Flanges (Covered by ASME B16.47-1996 Series A)	8-46 to 8-50
API Standard 605 - Cancelled (Covered by ASME B16.47-1996 Series B)	8-51 to 8-54
BS 10 : 1962 - Specification for Flanges and Bolting for Pipes, Valves, and Fittings	8-71
BS 3293 : 1960 (incorporating amendment 1972) - Specification for Carbon Steel Pipe Flanges (over 24 inches nominal size) for the Petroleum Industry	8-55
BS 4504 : Section 3.1 : 1989 (incorporating amendments) - Circular Flanges for Pipes, Valves and Fittings (PN designated), Section 3.1 Specification for Steel Flanges	8-60
ISO 7005-1 : 1992 (E), Metallic Flanges - Part 1: Steel Flanges (this is substantially the same as BS 4504)	8-60

Flanges - General Information

A Flange is a method of connecting pipes, valves, pumps and other equipment to form a pipework system. It also provides easy access for cleaning, inspection or modification. Flanges are usually welded or screwed into such systems and then joined with bolts.

Flange Types

Weld Neck

This flange is circumferentially welded into the system at its neck which means that the integrity of the butt welded area can be easily examined by radiography. The bores of both pipe and flange match, which reduces turbulence and erosion inside the pipeline. The weld neck is therefore favoured in critical applications

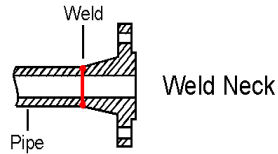

Slip-on

This flange is slipped over the pipe and then fillet welded. Slip-on flanges are easy to use in fabricated applications.

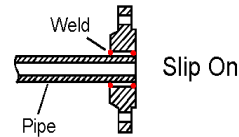

Blind

This flange is used to blank off pipelines, valves and pumps, it can also be used as an inspection cover. It is sometimes referred to as a blanking flange.

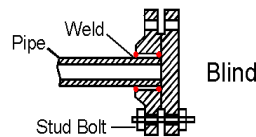

Socket Weld

This flange is counter bored to accept the pipe before being fillet welded. The bore of the pipe and flange are both the same therefore giving good flow characteristics.

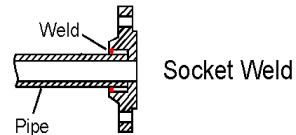

Threaded

This flange is referred to as either threaded or screwed. It is used to connect other threaded components in low pressure, non-critical applications. No welding is required.

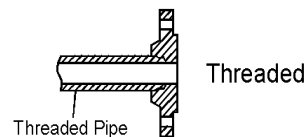

Lap Joint

These flanges are always used with either a stub end or taft which is butt welded to the pipe with the flange loose behind it. This means the stub end or taft always makes the face. The lap joint is favoured in low pressure applications because it is easily assembled and aligned. To reduce cost these flanges can be supplied without a hub and/or in treated, coated carbon steel.

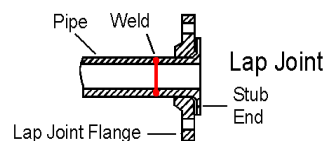

Ring Type Joint

This is a method of ensuring leak proof flange connection at high pressures. A metal ring is compressed into a hexagonal groove on the face of the flange to make the seal. This jointing method can be employed on Weld Neck, Slip-on and Blind Flanges.

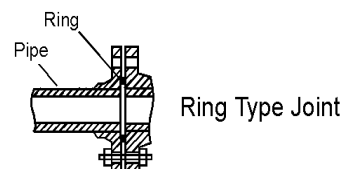

Flanges - General Information

Specifications

Refer to page 8-1 for a list of flange specifications (with page references) covered in this Section.

Manufacture

Summary of materials used for flanges

	ASME/ ANSI B16.5	ASME B16.47 Series A (or MSS SP-44 ¹)	ASME B16.47 Series B (or API 605 ²)	BS 4504	BS 3293	BS 10 ³
Forging (ASTM A 182)	✓	✓	✓	✓	✓	✓
Plate (ASTM A 240) ⁴	✓			✓		✓
Bar ⁵						✓
Casting ⁶	✓			✓		✓

Notes

- MSS SP-44 flanges are designated Series A flanges in ASME B16.47.
- API 605 has been cancelled. API 605 flanges are designated Series B flanges in ASME B16.47.
- BS 10, although obsolete, remains in use for light weight economy stainless steel flanges.
- Within specification ANSI B16.5, plate can only be used to provide blind flanges.
- Most small BS 10 flanges are made from bar.
- Castings are not included in this manual.

- **Materials.** Most standards specify the material from which the flange is produced. The purchaser should specify the exact requirements.
- **Flange Sizes.** All sizes and grades compatible to standard pipe ranges and wall thicknesses (pressure ratings) are available. The table below provides a summary.
- **Flange Face.** There are various face configurations for flanges. Typically: flat face, raised face, tongue and groove, ring joint.
- **Face Finish.** The finish on the face of a flange is measured as an Arithmetical Average Roughness Height (AARH). The finish is determined by the standard used. For example, ANSI B16.5 specifies face finishes within a range 125AARH - 500AARH (3.2 Ra to 12.5 Ra). Other finishes are available on request, for example 1.6 Ra max, 1.6/3.2 Ra, 3.2/6.3 Ra or 6.3/12.5 Ra. The range 3.2/6.3 Ra is most common.

Summary of flange sizes specified by common standards

Flange Type	Specifications				
	ASME/ANSI B16.5	ASME B16.47 Series A (or MSS SP-44 ¹)	ASME B16.47 Series B (or API 605 ²)	BS 4504 (ISO 7005-1)	BS 3293
	Nominal Pipe Sizes				
	< NPS 26	≥NPS 26	≥NPS 26	DN 10 to DN 4000	≥ NPS 26
	Nominal Pressure (Class)				
	Class (lb)	Class (lb)	Class (lb)	PN (bar)	Class (lb)
Weld Neck	150-2500	150-900	75-900	2.5-40	150-600
Slip-on	150-1500	-	-	2.5-40	150-600
Blind	150-2500	300-900	300-900	2.5-40	-
Lap Joint	150-2500	-	-	6-40 ³	-
Socket Weld	150-1500	-	-	N/A	-
Threaded	150-2500	-	-	6-40	-
Flat/Raised Facings	As above	As above	As above	As above	As above
Ring Joint Facings	150-2500	300-900	300-900	2.5-40	300-600
Other Facings	150-2500 ³	-	-	2.5-40	-

Notes

- MSS SP-44 flanges are designated Series A flanges in ASME B16.47. It also covers flanges in the range NPS 12 to 24, these being equivalent to ASME/ANSI B16.5 flanges in the same range (except for the addition of NPS 22 in MSS SP-44).
- API 605 has been cancelled. API 605 flanges are designated Series B flanges in ASME B16.47. Ranges quoted are based on ASME B16.47 Series B.
- Dimensions not covered in this summary.

ASME/ANSI B16.5-1996 and B16.47-1996

American national standards ASME/ANSI B16.5 and B16.47 together cover pipe flanges up to NPS 60 (NPS 48 is the largest detailed in this summary). ASME/ANSI B16.47 covers two series of flanges, Series A which is equivalent to MSS SP-44 (the 1996 Edition of MSS SP-44 complies with B16.47 tolerances), and Series B which is equivalent to API 605 (API 605 is now cancelled).

Dimensions and Tolerances

Tolerances on flange dimensions (ASME/ANSI B16.5 and B16.47, and MSS SP-44)

Dimension	Range	Tolerance	
		in	mm
General and Blind Flanges (For blind flange dimensions see page 8-23 for B16.5, page 8-46 for B16.47 Series A / MSS SP-44 and page 8-51 for B16.47 Series B / API 605):			
G (raised face diameter)	≤ NPS 24	±0.03	±0.76
	≥ NPS 26, with 0.06 in raised face	±0.08	±2.03
	≥ NPS 26, with 0.25 in raised face	±0.04	±1.02
I (bolt hole diameter)	All	No tolerance in B16.5 or B16.47	
J (bolt circle diameter)	All	±0.06	±1.52
Centre to centre of adjacent bolt holes	All	±0.03	±0.76
Eccentricity of bolt circle and machined facing diameters	≤ NPS 2½	±0.03	±0.76
	≥ NPS 3	±0.06	±1.52
Weld Neck Flanges ¹ (For dimensions see page 8-10 for B16.5, page 8-46 for B16.47 Series A / MSS SP-44 and page 8-51 for B16.47 Series B / API 605):			
D (overall length)	≤ NPS 4	+0.06	+1.52
	NPS 5 to 10	+0.06, -0.12	+1.52, -3.05
	NPS 12 to 24	+0.12, -0.18	+3.05, -4.57
	≥ NPS 26	±0.19	±4.83
Thickness of hub	All	> 87.5% of pipe nominal wall thickness	
Slip on (see page 8-17), Lap Joint (see page 8-32 for dimensions) and Socket Welding (see page 8-30 for dimensions) Flanges:			
B (inside diameter, or bore)	≤ NPS 10	+0.03, -0.0	+0.76, -0.0
	≥ NPS 12	+0.06, -0.0	+1.52, -0.0
Threaded Flanges (see page 8-40 for dimensions):			
B (counterbore) (Not applicable for Class 150 lb)	≤ NPS 10	+0.03, -0.0	+0.76, -0.0
	≥ NPS 12	+0.06, -0.0	+1.52, -0.0
Ring Joint Facing (See page 8-6 for dimensions; see page 8-9 for tolerances)			

Note

¹ See page 8-5 for weld neck welding end dimension and tolerance data.

General - ASME/ANSI B16.5 & B16.47

Weld Neck Flanges - Welding Ends

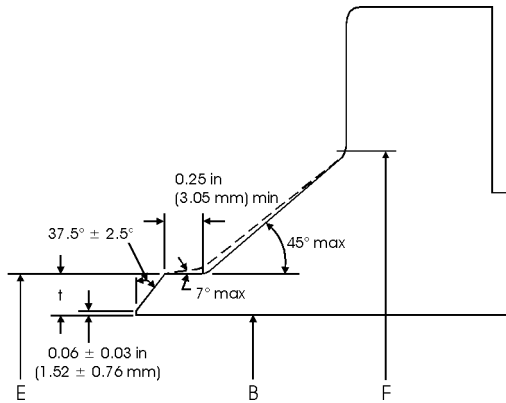

ASME/ANSI B16.5 (NPS $1/2$ to 24) Weld Neck Flange Bevel (with no backing ring) for Wall Thicknesses (t) from 0.19 to 0.88 in (4.83 to 22.35 mm).

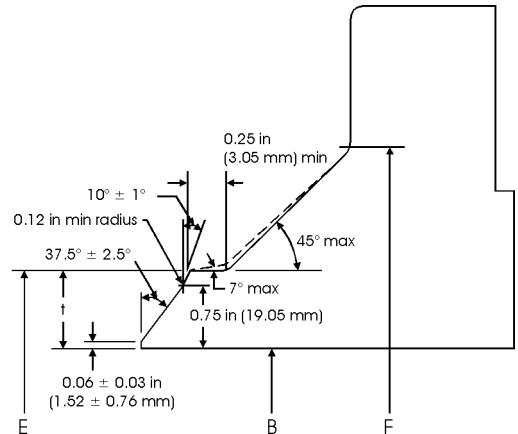

ASME/ANSI B16.5 (NPS $1/2$ to 24) Weld Neck Flange Bevel (with no backing ring) for Wall Thicknesses (t) > 0.88 in (22.35 mm).

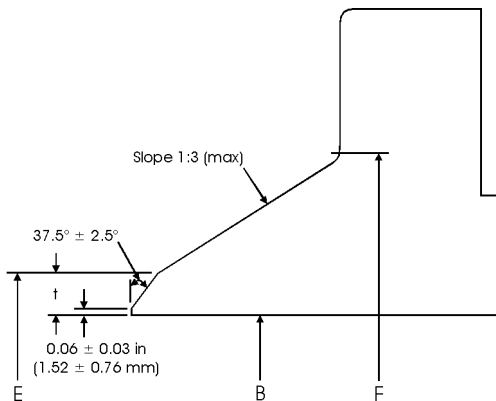

ASME B16.47 and MSS SP-44 ($>NPS$ 24) Weld Neck Flange Bevel (with no backing ring) for Wall Thickness (t) = 0.19 to 0.88 in (4.83 to 22.35 mm).

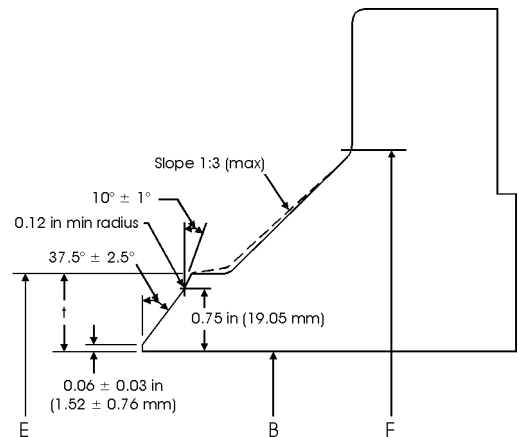

ASME B16.47 and MSS SP-44 ($>NPS$ 24) Weld Neck Flange Bevel (with no backing ring) for Wall Thicknesses (t) > 0.88 in (22.35 mm).

Tolerances on welding end dimensions (ASME/ANSI B16.5 and B16.47, and MSS SP-44)

Dimension	Range	Tolerance	
		in	mm
E (outside diameter at welding end)	$\leq NPS$ 5	+0.09, -0.03	+2.29, -0.76
	NPS 6 to 24	+0.16, -0.03	+4.06, -0.76
	$\geq NPS$ 26	+0.21, -0.06	+5.33, -1.52
B (inside diameter of flange)	$B \leq NPS$ 10	± 0.03	± 0.76
	$B \geq NPS$ 12 to 18	± 0.03	± 0.76
	$B \geq NPS$ 20	+0.12, -0.06	+3.05, -1.52
t (thickness at weld bevel)	All	$> 87.5\%$	

Note

- t = Nominal wall thickness of the pipe. Additional thickness at the weld bevel (up to 0.5 x t) may be provided on the inside or outside diameter (or partially on both) of the hub if it is used with light walled higher strength pipe. Hub diameter, F, may also be increased.

Ring Joint Facings - ASME/ANSI B16.5 & B16.47

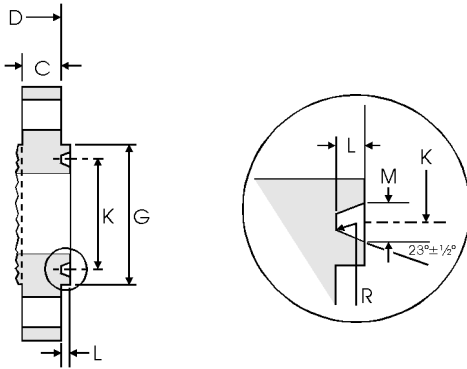

Note

- Values for minimum flange thickness, C, and overall length, D, are detailed in the flange tables.
- For ring joint tolerances see page 8-9.

Ring joint facing dimensions - ASME/ANSI B16.5 and B16.47 Series A (MSS SP-44) and Series B (API 605)

Class (lb)						Groove/Ring Number	Raised Face	Groove				
150	300	400	600	900	1500		2500	G	K	L	M	R
Nominal Pipe Size (NPS)							Face Diameter min	Pitch Diameter	Depth ¹	Width	Radius at Bottom	
							in mm	in mm	in mm	in mm	in mm	
ASME/ANSI B16.5 covers NPS 1/2 to 24:												
	1/2		1/2			R11	2.000 50.80	1.344 34.14	0.219 5.56	0.281 7.14	0.03 0.76	
				1/2		R12	2.380 60.45	1.562 39.67	0.250 6.35	0.344 8.74	0.03 0.76	
		3/4				R13	2.500 63.50	1.688 42.88	0.250 6.35	0.344 8.74	0.03 0.76	
					1/2	R13	2.560 65.02	1.688 42.88	0.250 6.35	0.344 8.74	0.03 0.76	
				3/4		R14	2.620 66.55	1.750 44.45	0.250 6.35	0.344 8.74	0.03 0.76	
1						R15	2.500 63.50	1.875 47.63	0.250 6.35	0.344 8.74	0.03 0.76	
	1					R16	2.750 69.85	2.000 50.80	0.250 6.35	0.344 8.74	0.03 0.76	
			1			R16	2.810 71.37	2.000 50.80	0.250 6.35	0.344 8.74	0.03 0.76	
					3/4	R16	2.880 73.15	2.000 50.80	0.250 6.35	0.344 8.74	0.03 0.76	
	1 1/4					R17	2.880 73.15	2.250 57.15	0.250 6.35	0.344 8.74	0.03 0.76	
		1 1/4				R18	3.120 79.25	2.375 60.33	0.250 6.35	0.344 8.74	0.03 0.76	
			1 1/4			R18	3.190 81.03	2.375 60.33	0.250 6.35	0.344 8.74	0.03 0.76	
					1	R18	3.250 82.55	2.375 60.33	0.250 6.35	0.344 8.74	0.03 0.76	
	1 1/2					R19	3.250 82.55	2.562 65.07	0.250 6.35	0.344 8.74	0.03 0.76	
		1 1/2				R20	3.560 90.42	2.688 68.28	0.250 6.35	0.344 8.74	0.03 0.76	
			1 1/2			R20	3.620 91.95	2.688 68.28	0.250 6.35	0.344 8.74	0.03 0.76	
					1 1/4	R21	4.000 101.60	2.844 72.24	0.312 7.92	0.469 11.91	0.03 0.76	
						R22	4.000 101.60	3.250 82.55	0.250 6.35	0.344 8.74	0.03 0.76	
						R23	4.250 107.95	3.250 82.55	0.312 7.92	0.469 11.91	0.03 0.76	
					1 1/2	R23	4.500 114.30	3.250 82.55	0.312 7.92	0.469 11.91	0.03 0.76	
					2	R24	4.880 123.95	3.750 95.25	0.312 7.92	0.469 11.91	0.03 0.76	
	2 1/2					R25	4.750 120.65	4.000 101.60	0.250 6.35	0.344 8.74	0.03 0.76	
		2 1/2				R26	5.000 127.00	4.000 101.60	0.312 7.92	0.469 11.91	0.03 0.76	
					2	R26	5.250 133.35	4.000 101.60	0.312 7.92	0.469 11.91	0.03 0.76	

Use Class 600 for sizes ≤ 3 1/2

Use Class 1500 for sizes ≤ 2 1/2

Ring Joint Facings - ASME/ANSI B16.5 & B16.47

Ring joint facing dimensions - ASME/ANSI B16.5 and B16.47 Series A (MSS SP-44) and Series B (API 605) (Continued)

Class (lb)							Groove/Ring Number	Groove				
150	300	400	600	900	1500	2500		G	K	L	M	R
Nominal Pipe Size (NPS)								Face Diameter min	Pitch Diameter	Depth ¹	Width	Radius at Bottom
								in mm	in mm	in mm	in mm	in mm
					2 1/2		R27	5.380 136.65	4.250 107.95	0.31 27.92	0.469 11.91	0.03 0.76
						2 1/2	R28	5.880 149.35	4.37511 1.13	0.375 9.53	0.531 13.49	0.06 1.52
3							R29	5.250 133.35	4.500 114.30	0.250 6.35	0.344 8.74	0.03 0.76
	2						R30	-	4.625 117.48	0.312 7.92	0.469 11.91	0.03 0.76
	3 ²						R31	5.750 146.05	4.875 123.83	0.312 7.92	0.469 11.91	0.03 0.76
				3			R31	6.120 155.45	4.875 123.83	0.312 7.92	0.469 11.91	0.03 0.76
					3		R32	6.620 168.15	5.000 127.00	0.375 9.53	0.531 13.49	0.06 1.52
	3 1/2						R33	6.060 153.92	5.188 131.78	0.250 6.35	0.344 8.74	0.03 0.76
	3 1/2		3 1/2				R34	6.250 158.75	5.188 131.78	0.312 7.92	0.469 11.91	0.03 0.76
					3		R35	6.620 168.15	5.375 136.53	0.312 7.92	0.469 11.91	0.03 0.76
4							R36	6.750 171.45	5.875 149.23	0.250 6.35	0.344 8.74	0.03 0.76
	4	4	4				R37	6.880 174.75	5.875 149.23	0.312 7.92	0.469 11.91	0.03 0.76
				4			R37	7.120 180.85	5.875 149.23	0.312 7.92	0.469 11.91	0.03 0.76
					4		R38	8.000 203.20	6.1881 57.18	0.438 11.13	0.656 16.66	0.06 1.52
					4		R39	7.620 193.55	6.375 161.93	0.312 7.92	0.469 11.91	0.03 0.76
5							R40	7.620 193.55	6.750 171.45	0.250 6.35	0.344 8.74	0.03 0.76
	5	5	5				R41	8.250 209.55	7.125 180.98	0.312 7.92	0.469 11.91	0.03 0.76
				5			R41	8.500 215.90	7.125 180.98	0.312 7.92	0.469 11.91	0.03 0.76
					5		R42	9.500 241.30	7.500 190.50	0.500 12.70	0.781 19.84	0.06 1.52
6							R43	8.620 218.95	7.625 193.68	0.250 6.35	0.344 8.74	0.03 0.76
					5		R44	9.000 228.60	7.625 193.68	0.312 7.92	0.469 11.91	0.03 0.76
	6	6	6				R45	9.500 241.30	8.312 211.12	0.312 7.92	0.469 11.91	0.03 0.76
				6			R45	9.500 241.30	8.312 211.12	0.312 7.92	0.469 11.91	0.03 0.76
					6		R46	9.750 247.65	8.312 211.12	0.375 9.53	0.531 13.49	0.06 1.52
					6		R47	11.000 279.40	9.000 228.60	0.500 12.70	0.781 19.84	0.06 1.52
8							R48	10.750 273.05	9.750 247.65	0.250 6.35	0.344 8.74	0.03 0.76
	8	8	8				R49	11.880 301.75	10.625 269.88	0.312 7.92	0.469 11.91	0.03 0.76
				8			R49	12.120 307.85	10.625 269.88	0.312 7.92	0.469 11.91	0.03 0.76
					8		R50	12.500 317.50	10.625 269.88	0.438 11.13	0.656 16.66	0.06 1.52
					8		R51	13.380 339.85	11.000 279.40	0.562 14.27	0.906 23.01	0.06 1.52
10							R52	13.000 330.20	12.000 304.80	0.250 6.35	0.344 8.74	0.03 0.76
	10	10	10				R53	14.000 355.60	12.750 323.85	0.312 7.92	0.469 11.91	0.03 0.76
				10			R53	14.250 361.95	12.750 323.85	0.312 7.92	0.469 11.91	0.03 0.76
					10		R54	14.620 371.35	12.750 323.85	0.438 11.13	0.656 16.66	0.06 1.52

Use Class 600 for sizes < 3 1/2

Ring Joint Facings - ASME/ANSI B16.5 & B16.47

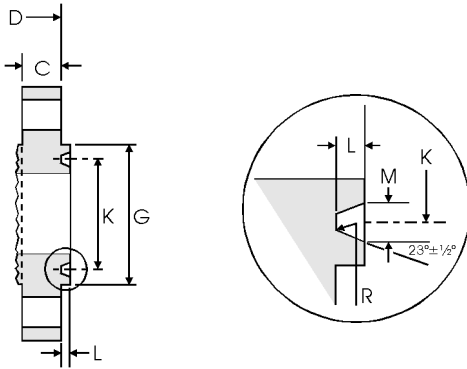

Note

- Values for minimum flange thickness, C, and overall length, D, are detailed in the flange tables.
- For ring joint tolerances see page 8-9.

Ring joint facing dimensions - ASME/ANSI B16.5 and B16.47 Series A (MSS SP-44) and Series B (API 605) (Continued)

Class (lb)							Groove/Ring Number	Raised Face	Groove			
150	300	400	600	900	1500	2500		G	K	L	M	R
Nominal Pipe Size (NPS)								Face Diameter min	Pitch Diameter	Depth ¹	Width	Radius at Bottom
								in mm	in mm	in mm	in mm	in mm
						10	R55	16.750 425.45	13.500 342.90	0.688 17.48	1.188 30.18	0.09 2.29
12							R56	16.000 406.40	15.000 381.00	0.250 6.35	0.344 8.74	0.03 0.76
	12	12	12				R57	16.250 412.75	15.000 381.00	0.312 7.92	0.469 11.91	0.03 0.76
				12			R57	16.500 419.10	15.000 381.00	0.312 7.92	0.469 11.91	0.03 0.76
					12		R58	17.250 438.15	15.000 381.00	0.562 14.27	0.906 23.01	0.06 1.52
14							R59	16.750 425.45	15.625 396.88	0.250 6.35	0.344 8.74	0.03 0.76
						12	R60	19.500 495.30	16.000 406.40	0.688 17.48	1.312 33.32	0.09 2.29
	14	14	14				R61	18.000 457.20	16.500 419.10	0.312 7.92	0.469 11.91	0.03 0.76
				14			R62	18.380 466.85	16.500 419.10	0.438 11.13	0.656 16.66	0.06 1.52
					14		R63	19.250 488.95	16.500 419.10	0.625 15.88	1.062 26.97	0.09 2.29
16							R64	19.000 482.60	17.875 454.03	0.250 6.35	0.344 8.74	0.03 0.76
	16	16	16				R65	20.000 508.00	18.500 469.90	0.312 7.92	0.469 11.91	0.03 0.76
				16			R66	20.620 523.75	18.500 469.90	0.438 11.13	0.656 16.66	0.06 1.52
					16		R67	21.500 546.10	18.500 469.90	0.688 17.48	1.188 30.18	0.09 2.29
18							R68	21.500 546.10	20.375 517.53	0.250 6.35	0.344 8.74	0.03 0.76
	18	18	18				R69	22.620 574.55	21.000 533.40	0.312 7.92	0.469 11.91	0.03 0.76
				18			R70	23.380 593.85	21.000 533.40	0.500 12.70	0.781 19.84	0.06 1.52
					18		R71	24.120 612.65	21.000 533.40	0.688 17.48	1.188 30.18	0.09 2.29
20							R72	23.500 596.90	22.000 558.80	0.250 6.35	0.344 8.74	0.03 0.76
	20	20	20				R73	25.000 635.00	23.000 584.20	0.375 9.53	0.531 13.49	0.06 1.52
				20			R74	25.500 647.70	23.000 584.20	0.500 12.70	0.781 19.84	0.06 1.52
					20		R75	26.500 673.10	23.000 584.20	0.688 17.48	1.312 33.32	0.09 2.29
24							R76	28.000 711.20	26.500 673.10	0.250 6.35	0.344 8.74	0.03 0.76
	24	24	24				R77	29.500 749.30	27.250 692.15	0.438 11.13	0.656 16.66	0.06 1.52
				24			R78	30.380 771.65	27.250 692.15	0.625 15.88	1.062 26.97	0.09 2.29

Ring Joint Facings - ASME/ANSI B16.5 & B16.47

Ring joint facing dimensions - ASME/ANSI B16.5 and B16.47 Series A (MSS SP-44) and Series B (API 605) (Continued)

Class (lb)							Groove/Ring Number	Raised Face		Groove				
150	300	400	600	900	1500	2500		G	K	L	M	R		
Nominal Pipe Size (NPS)								Face Diameter min	Pitch Diameter	Depth ¹	Width	Radius at Bottom		
							in mm	in mm	in mm	in mm	in mm			
					24		R79	31.250 793.75	27.250 692.15	0.812 20.62	1.438 36.53	0.09 2.29		
MSS SP-44 only, covers NPS 22:														
	22	22	22				R81	27.000 685.80	25.000 635.00	0.438 11.13	0.594 15.09	0.06 1.52		
ASME/ANSI B16.47 (MSS SP-44 & API 605) covers NPS 26 to 36. (There are no ring joint facings >NPS 36)														
	26	26	26				R93	31.880 809.75	29.500 749.30	0.500 12.70	0.781 19.84	0.06 1.52		
	28	28	28				R94	33.880 860.55	31.500 800.10	0.500 12.70	0.781 19.84	0.06 1.52		
	30	30	30				R95	36.120 917.45	33.750 857.25	0.500 12.70	0.781 19.84	0.06 1.52		
	32	32	32				R96	38.750 984.25	36.000 914.40	0.562 14.27	0.906 23.01	0.06 1.52		
	34	34	34				R97	40.750 1035.1	38.000 965.20	0.562 14.27	0.906 23.01	0.06 1.52		
	36	36	36				R98	43.000 1092.2	40.250 1022.4	0.562 14.27	0.906 23.01	0.06 1.52		
				26			R100	32.750 831.85	29.500 749.30	0.688 17.48	1.188 30.18	0.09 2.29		
				28			R101	35.000 889.00	31.500 800.10	0.688 17.48	1.312 33.32	0.09 2.29		
				30			R102	37.250 946.15	33.750 857.25	0.688 17.48	1.312 33.32	0.09 2.29		
				32			R103	39.500 1003.3	36.000 914.40	0.688 17.48	1.312 33.32	0.09 2.29		
				34			R104	42.000 1066.8	38.000 965.20	0.812 20.62	1.438 36.53	0.09 2.29		
				36			R105	44.250 1124.0	40.250 1022.4	0.812 20.62	1.438 36.53	0.09 2.29		

Notes

- Ring joint gasket dimensions conform to ASME B16.20 (not covered in this summary).
 - Use Class 600 lb in sizes NPS 1/2 to NPS 3 1/2 for Class 400 lb.
 - Use Class 1500 lb in sizes NPS 1/2 to NPS 2 1/2 for Class 900 lb.
 - Tolerances are as shown in the table below.
- 1 The height of the raised portion is equal to the depth of groove dimension L, but is not subject to the tolerances for L.
 - 2 Ring joints with lapped flanges in Classes 300 lb and 600 lb use R30 instead of R31.

Ring joint facing tolerances (ASME/ANSI B16.5 and B16.47)

Dimension	Range	Tolerance	
		in	mm
L (depth)	All	+0.016, -0	+0.406, -0
M (width)	All	±0.008	±0.203
K (pitch diameter)	All	±0.005	±0.127
R (radius at bottom)	R ≤ 0.06 in	+0.03, -0	+0.762, -0
	R > 0.06 in	±0.03	±0.762
D (overall length) for flanges with ring joint	≤ NPS 10	±0.06	±1.52
	≥ NPS 12	±0.12	±3.05

Weld Neck Flanges - ANSI B16.5

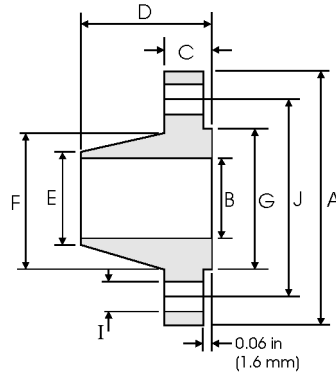

Class 150 lb

Pipe		Flange Data				Hub Data		Raised Face	Drilling Data			Weight
Nominal Pipe Size		A	B	C	D	E	F	G	H	I	J	
	Outside Diameter	Overall Diameter	Inside Diameter	Flange Thickness min	Overall Length	Diameter at Weld Bevel	Hub Diameter	Face Diameter	Number of Holes	Bolt Hole Diameter	Diameter of Circle of Holes	kg/ piece
	in mm	in mm	in mm	in mm	in mm	in mm	in mm	in mm		in mm	in mm	
1/2	0.840	3.500	0.620	0.440	1.880	0.840	1.190	1.380	4	0.620	2.380	0.48
	21.30	88.90	15.70	11.20	47.80	21.30	30.20	35.00		15.70	60.45	
3/4	1.050	3.880	0.820	0.500	2.060	1.050	1.500	1.690	4	0.620	2.750	0.71
	26.70	98.60	20.80	12.70	52.30	26.70	38.10	42.90		15.70	69.85	
1	1.315	4.250	1.050	0.560	2.190	1.320	1.940	2.000	4	0.620	3.120	1.01
	33.40	108.0	26.70	14.20	55.60	33.50	49.30	50.80		15.70	79.25	
1 1/4	1.660	4.620	1.380	0.620	2.250	1.660	2.310	2.500	4	0.620	3.500	1.33
	42.20	117.3	35.10	15.70	57.15	42.20	58.70	63.50		15.70	88.90	
1 1/2	1.900	5.000	1.610	0.690	2.440	1.900	2.560	2.880	4	0.620	3.880	1.72
	48.30	127.0	40.90	17.50	62.00	48.30	65.00	73.15		15.70	98.60	
2	2.375	6.000	2.070	0.750	2.500	2.380	3.060	3.620	4	0.750	4.750	2.58
	60.30	152.4	52.60	19.10	63.50	60.45	77.70	91.90		19.10	120.7	
2 1/2	2.875	7.000	2.470	0.880	2.750	2.880	3.560	4.120	4	0.750	5.500	4.11
	73.00	177.8	62.70	22.40	69.85	73.15	90.40	104.6		19.10	139.7	
3	3.500	7.500	3.070	0.940	2.750	3.500	4.250	5.000	4	0.750	6.000	4.92
	88.90	190.5	78.00	23.90	69.85	88.90	108.0	127.0		19.10	152.4	
3 1/2	4.000	8.500	3.550	0.940	2.810	4.000	4.810	5.500	8	0.750	7.000	6.08
	101.6	215.9	90.20	23.90	71.40	101.6	122.2	139.7		19.10	177.8	
4	4.500	9.000	4.030	0.940	3.000	4.500	5.310	6.190	8	0.750	7.500	6.84
	114.3	228.6	102.4	23.90	76.20	114.3	134.9	157.2		19.10	190.5	
5	5.563	10.00	5.050	0.940	3.500	5.560	6.440	7.310	8	0.880	8.500	8.56
	141.3	254.0	128.3	23.90	88.90	141.2	163.6	185.7		22.40	215.9	
6	6.625	11.00	6.070	1.000	3.500	6.630	7.560	8.500	8	0.880	9.500	10.6
	168.3	279.4	154.2	25.40	88.90	168.4	192.0	215.9		22.40	241.3	
8	8.625	13.50	7.980	1.120	4.000	8.630	9.690	10.62	8	0.880	11.75	17.6
	219.1	342.9	202.7	28.40	101.6	219.2	246.1	269.7		22.40	298.5	
10	10.75	16.00	10.02	1.190	4.000	10.75	12.00	12.75	12	1.000	14.25	24.0
	273.0	406.4	254.5	30.20	101.6	273.0	304.8	323.8		25.40	362.0	
12	12.75	19.00	12.00	1.250	4.500	12.75	14.38	15.00	12	1.000	17.00	36.5
	323.8	482.6	304.8	31.75	114.3	323.8	365.3	381.0		25.40	431.8	
14	14.00	21.00		1.380	5.000	14.00	15.75	16.25	12	1.120	18.75	48.4
	355.6	533.4		35.10	127.0	355.6	400.1	412.7		28.40	476.3	
16	16.00	23.50		1.440	5.000	16.00	18.00	18.50	16	1.120	21.25	60.6
	406.4	596.9		36.60	127.0	406.4	475.2	469.9		28.40	539.8	
18	18.00	25.00		1.560	5.500	18.00	19.88	21.00	16	1.250	22.75	68.3
	457.2	635.0		39.60	139.7	457.2	505.0	533.4		31.75	577.9	
20	20.00	27.50		1.690	5.690	20.00	22.00	23.00	20	1.250	25.00	84.5
	508.0	698.5		42.90	144.5	508.0	558.8	584.2		31.75	635.0	
24	24.00	32.00		1.880	6.000	24.00	26.12	27.25	20	1.380	29.50	115
	609.6	812.8		47.80	152.4	609.6	663.4	692.1		35.10	749.3	

Notes

- Dimension B corresponds to the pipe inside diameter. Values quoted assume 40S/Standard wall thickness.
- Weights are based on manufacturer's data and are approximate.
- Flat face flanges may be provided at full thickness, C, or with raised face removed (the latter is nonstandard).
- For ring joint facings see page 8-6. For weld end bevel see page 8-5.
- For tolerances see page 8-4.

Weld Neck Flanges - ANSI B16.5

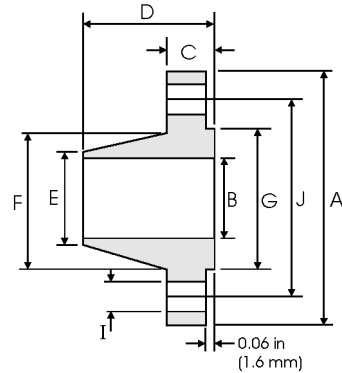

Class 300 lb

Nominal Pipe Size	Pipe		Flange Data				Hub Data		Raised Face	Drilling Data			Weight
	Outside Diameter	Overall Diameter	Inside Diameter	Flange Thickness min	Overall Length	Diameter at Weld Bevel	Hub Diameter	Face Diameter	Number of Holes	Bolt Hole Diameter	Diameter of Circle of Holes	kg/ piece	
													A
1/2	0.840 21.30	3.750 95.20	0.620 15.70	0.560 14.20	2.060 52.30	0.840 21.30	1.500 38.10	1.380 35.00	4	0.620 15.70	2.620 66.55	0.75	
3/4	1.050 26.70	4.620 117.3	0.820 20.80	0.620 15.70	2.250 57.15	1.050 26.70	1.880 47.70	1.690 42.90	4	0.750 19.00	3.250 82.50	1.26	
1	1.315 33.40	4.880 123.9	1.050 26.70	0.690 17.50	2.440 62.00	1.320 33.50	2.120 53.80	2.000 50.80	4	0.750 19.00	3.500 88.90	1.52	
1 1/4	1.660 42.20	5.250 133.3	1.380 35.10	0.750 19.00	2.560 65.00	1.660 42.20	2.500 63.50	2.500 63.50	4	0.750 19.00	3.880 98.50	2.03	
1 1/2	1.900 48.30	6.120 155.4	1.610 40.90	0.810 20.60	2.690 68.30	1.900 48.30	2.750 69.85	2.880 73.15	4	0.880 22.30	4.500 114.3	2.89	
2	2.375 60.30	6.500 165.1	2.070 52.60	0.880 22.30	2.750 69.85	2.380 60.45	3.310 84.00	3.620 91.90	8	0.750 19.00	5.000 127.0	3.40	
2 1/2	2.875 73.00	7.500 190.5	2.470 62.70	1.000 25.40	3.000 76.20	2.880 73.15	3.940 100.0	4.120 104.6	8	0.880 22.30	5.880 149.3	5.17	
3	3.500 88.90	8.250 209.5	3.070 78.00	1.120 28.40	3.120 79.25	3.500 88.90	4.620 117.3	5.000 127.0	8	0.880 22.30	6.620 168.1	6.93	
3 1/2	4.000 101.6	9.000 228.6	3.550 90.20	1.190 30.20	3.190 81.00	4.000 101.6	5.250 133.3	5.500 139.7	8	0.880 22.30	7.250 184.1	8.67	
4	4.500 114.3	10.00 254.0	4.030 102.4	1.250 31.70	3.380 85.80	4.500 114.3	5.750 146.0	6.190 157.2	8	0.880 22.30	7.880 200.1	11.2	
5	5.563 141.3	11.00 279.4	5.050 128.3	1.380 35.00	3.880 98.50	5.560 141.2	7.000 177.8	7.310 185.7	8	0.880 22.30	9.250 234.9	15.1	
6	6.625 168.3	12.50 317.5	6.070 154.2	1.440 36.50	3.880 98.50	6.630 168.4	8.120 206.2	8.500 215.9	12	0.880 22.30	10.62 269.7	19.1	
8	8.625 219.1	15.00 381.0	7.980 202.7	1.620 41.10	4.380 111.2	8.630 219.2	10.25 260.3	10.62 269.7	12	1.000 25.40	13.00 330.2	29.9	
10	10.75 273.0	17.50 444.5	10.02 254.5	1.880 47.70	4.620 117.3	10.75 273.0	12.62 320.5	12.75 323.8	16	1.120 28.40	15.25 387.3	42.7	
12	12.75 323.8	20.50 520.7	12.00 304.8	2.000 50.80	5.120 130.0	12.75 323.8	14.75 374.6	15.00 381.0	16	1.250 31.70	17.75 450.8	61.8	
14	14.00 355.6	23.00 584.2	To be specified by Purchaser	2.120 53.80	5.620 142.7	14.00 355.6	16.75 425.4	16.25 412.7	20	1.250 31.70	20.25 514.3	85.8	
16	16.00 406.4	25.50 647.7		2.250 57.15	5.750 146.0	16.00 406.4	19.00 482.6	18.50 469.9	20	1.380 35.00	22.50 571.5	106	
18	18.00 457.2	28.00 711.2		2.380 60.45	6.250 158.7	18.00 457.2	21.00 533.4	21.00 533.4	24	1.380 35.00	24.75 628.6	131	
20	20.00 508.0	30.50 774.7		2.500 63.50	6.380 162.0	20.00 508.0	23.12 587.2	23.00 584.2	24	1.380 35.00	27.00 685.8	158	
24	24.00 609.6	36.00 914.4		2.750 69.85	6.620 168.1	24.00 609.6	27.62 701.5	27.25 692.1	24	1.620 41.10	32.00 812.8	230	



Notes

- Dimension B corresponds to the pipe inside diameter. Values quoted assume 40S/Standard wall thickness.
- Weights are based on manufacturer's data and are approximate.
- Flat face flanges may be provided at full thickness, C, or with raised face removed (the latter is nonstandard).
- For ring joint facings see page 8-6. For weld end bevel see page 8-5.
- For tolerances see page 8-4.

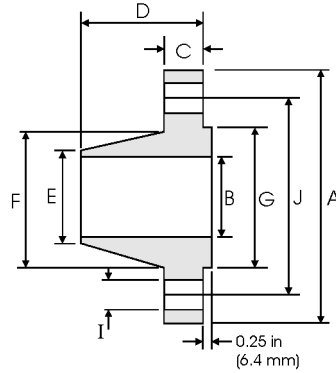
Weld Neck Flanges - ANSI B16.5



Class 400 lb

Pipe		Flange Data				Hub Data		Raised Face	Drilling Data			Weight
Nominal Pipe Size		A	B	C	D	E	F	G	H	I	J	
	Outside Diameter	Overall Diameter	Inside Diameter	Flange Thickness min	Overall Length	Diameter at Weld Bevel	Hub Diameter	Face Diameter	Number of Holes	Bolt Hole Diameter	Diameter of Circle of Holes	kg/ piece
	in mm	in mm	in mm	in mm	in mm	in mm	in mm	in mm		in mm	in mm	
1/2	0.840	3.750	To be specified by Purchaser	0.560	2.060	0.840	1.500	1.380	4	0.620	2.620	0.87
	21.30	95.30		14.20	52.30	21.30	38.10	35.00		15.70	66.55	
3/4	1.050	4.620		0.620	2.250	1.050	1.880	1.690	4	0.750	3.250	1.45
	26.70	117.3		15.70	57.15	26.70	47.80	42.90		19.10	82.60	
1	1.315	4.880		0.690	2.440	1.320	2.120	2.000	4	0.750	3.500	1.76
	33.40	124.0		17.50	62.00	33.50	53.80	50.80		19.10	88.90	
1 1/4	1.660	5.250		0.810	2.620	1.660	2.500	2.500	4	0.750	3.880	2.49
	42.20	133.4		20.60	66.55	42.20	63.50	63.50		19.10	98.60	
1 1/2	1.900	6.120		0.880	2.750	1.900	2.750	2.880	4	0.880	4.500	3.49
	48.30	155.4		22.40	69.85	48.30	69.85	73.15		22.40	114.3	
2	2.375	6.500		1.000	2.880	2.380	3.310	3.620	8	0.750	5.000	4.36
	60.30	165.1		25.40	73.15	60.45	84.10	91.90		19.10	127.0	
2 1/2	2.875	7.500		1.120	3.120	2.880	3.940	4.120	8	0.880	5.880	6.43
	73.00	190.5		28.40	79.25	73.15	100.1	104.6		22.40	149.4	
3	3.500	8.250		1.250	3.250	3.500	4.620	5.000	8	0.880	6.620	8.53
	88.90	209.6		31.75	82.60	88.90	117.3	127.0		22.40	168.1	
3 1/2	4.000	9.000		1.380	3.380	4.000	5.250	5.500	8	1.000	7.250	10.7
	101.6	228.6		35.10	85.90	101.6	133.4	139.7		25.40	184.2	
4	4.500	10.00		1.380	3.500	4.500	5.750	6.190	8	1.000	7.880	12.8
	114.3	254.0		35.10	88.90	114.3	146.1	157.2		25.40	200.2	
5	5.563	11.00	1.500	4.000	5.560	7.000	7.310	8	1.000	9.250	16.9	
	141.3	279.4	38.10	101.6	141.2	177.8	185.7		25.40	235.0		
6	6.625	12.50	1.620	4.060	6.630	8.120	8.500	12	1.000	10.62	22.0	
	168.3	317.5	41.10	103.1	168.4	206.2	215.9		25.40	269.7		
8	8.625	15.00	1.880	4.620	8.630	10.25	10.62	12	1.120	13.00	34.7	
	219.1	381.0	47.80	117.3	219.2	260.4	269.7		28.40	330.2		
10	10.75	17.50	2.120	4.880	10.75	12.62	12.75	16	1.250	15.25	48.5	
	273.0	444.5	53.80	124.0	273.0	320.5	323.8		31.75	387.4		
12	12.75	20.50	2.250	5.380	12.75	14.75	15.00	16	1.380	17.75	69.6	
	323.8	520.7	57.15	136.7	323.8	374.7	381.0		35.10	450.9		
14	14.00	23.00	2.380	5.880	14.00	16.75	16.25	20	1.380	20.25	95.5	
	355.6	584.2	60.45	149.4	355.6	425.5	412.7		35.10	514.4		
16	16.00	25.50	2.500	6.000	16.00	19.00	18.50	20	1.500	22.50	118	
	406.4	647.7	63.50	152.4	406.4	482.6	469.9		38.10	571.5		
18	18.00	28.00	2.620	6.500	18.00	21.00	21.00	24	1.500	24.75	145	
	457.2	711.2	66.55	165.1	457.2	533.4	533.4		38.10	628.7		
20	20.00	30.50	2.750	6.620	20.00	23.12	23.00	24	1.620	27.00	173	
	508.0	774.7	69.85	168.1	508.0	587.2	584.2		41.10	685.8		
24	24.00	36.00	3.000	6.880	24.00	27.62	27.25	24	1.880	32.00	249	
	609.6	914.4	76.20	174.8	609.6	701.5	692.1		47.80	812.8		

Notes

- Dimension B corresponds to the pipe inside diameter. Values quoted assume 40S/Standard wall thickness.
- Weights are based on manufacturer's data and are approximate.
- For ring joint facings see page 8-6. For weld end bevel see page 8-5.
- For tolerances see page 8-4.

Weld Neck Flanges - ANSI B16.5

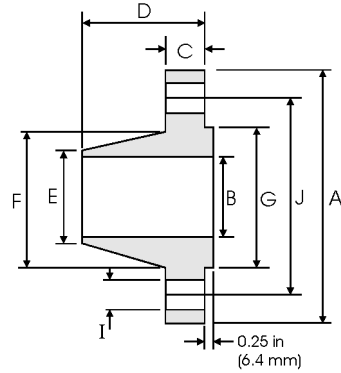

Class 600 lb

Nominal Pipe Size	Pipe		Flange Data				Hub Data		Raised Face	Drilling Data			Weight
	Outside Diameter	Overall Diameter	A	B	C	D	E	F	G	H	I	J	kg/ piece
1/2	0.840	3.750	0.560	2.060	0.840	1.500	1.380	4	0.620	2.620	0.87		
	21.30	95.30										15.70	66.55
3/4	1.050	4.620	0.620	2.250	1.050	1.880	1.690	4	0.750	3.250	1.45		
	26.70	117.3										19.10	82.60
1	1.315	4.880	0.690	2.440	1.320	2.120	2.000	4	0.750	3.500	1.76		
	33.40	124.0										19.10	88.90
1 1/4	1.660	5.250	0.810	2.620	1.660	2.500	2.500	4	0.750	3.880	2.49		
	42.20	133.4										20.60	66.55
1 1/2	1.900	6.120	0.880	2.750	1.900	2.750	2.880	4	0.880	4.500	3.49		
	48.30	155.4										22.40	69.85
2	2.375	6.500	1.000	2.880	2.380	3.310	3.620	8	0.750	5.000	4.36		
	60.30	165.1										25.40	73.15
2 1/2	2.875	7.500	1.120	3.120	2.880	3.940	4.120	8	0.880	5.880	6.43		
	73.00	190.5										28.40	79.25
3	3.500	8.250	1.250	3.250	3.500	4.620	5.000	8	0.880	6.620	8.53		
	88.90	209.6										31.75	82.60
3 1/2	4.000	9.000	1.380	3.380	4.000	5.250	5.500	8	1.000	7.250	10.7		
	101.6	228.6										35.10	85.90
4	4.500	10.75	1.500	4.000	4.500	6.000	6.190	8	1.000	8.500	17.4		
	114.3	273.1										38.10	101.6
5	5.563	13.00	1.750	4.500	5.560	7.440	7.310	8	1.120	10.50	29.2		
	141.3	330.2										44.50	114.3
6	6.625	14.00	1.880	4.620	6.630	8.750	8.500	12	1.120	11.50	34.9		
	168.3	355.6										47.80	117.3
8	8.625	16.50	2.190	5.250	8.630	10.75	10.62	12	1.250	13.75	53.9		
	219.1	419.1										55.60	133.4
10	10.75	20.00	2.500	6.000	10.75	13.50	12.75	16	1.380	17.00	86.5		
	273.0	508.0										63.50	152.4
12	12.75	22.00	2.620	6.120	12.75	15.75	15.00	20	1.380	19.25	103		
	323.8	558.8										66.55	155.4
14	14.00	23.75	2.750	6.500	14.00	17.00	16.25	20	1.500	20.75	122		
	355.6	603.3										69.85	165.1
16	16.00	27.00	3.000	7.000	16.00	19.50	18.50	20	1.620	23.75	170		
	406.4	685.8										76.20	177.8
18	18.00	29.25	3.250	7.250	18.00	21.50	21.00	20	1.750	25.75	204		
	457.2	743.0										82.60	184.2
20	20.00	32.00	3.500	7.500	20.00	24.00	23.00	24	1.750	28.50	254		
	508.0	812.8										88.90	190.5
24	24.00	37.00	4.000	8.000	24.00	28.25	27.25	24	2.000	33.00	358		
	609.6	939.8										101.6	203.2

To be specified by Purchaser



Notes

- Dimension B corresponds to the pipe inside diameter. Values quoted assume 40S/Standard wall thickness.
- Weights are based on manufacturer's data and are approximate.
- For ring joint facings see page 8-6. For weld end bevel see page 8-5.
- For tolerances see page 8-4.

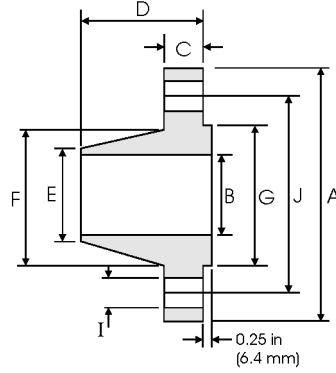
Weld Neck Flanges - ANSI B16.5



Class 900 lb

Pipe		Flange Data				Hub Data		Raised Face	Drilling Data			Weight
Nominal Pipe Size		A	B	C	D	E	F	G	H	I	J	
	Outside Diameter	Overall Diameter	Inside Diameter	Flange Thickness min	Overall Length	Diameter at Weld Bevel	Hub Diameter	Face Diameter	Number of Holes	Bolt Hole Diameter	Diameter of Circle of Holes	kg/ piece
	in mm	in mm	in mm	in mm	in mm	in mm	in mm	in mm		in mm	in mm	
1/2	0.840	4.750	To be specified by Purchaser	0.880	2.380	0.840	1.500	1.380	4	0.880	3.250	1.87
	21.30	120.6		22.30	60.45	21.30	38.10	35.00		22.30	82.50	
3/4	1.050	5.120		1.000	2.750	1.050	1.750	1.690	4	0.880	3.500	2.56
	26.70	130.0		25.40	69.85	26.70	44.00	42.90		22.30	88.90	
1	1.315	5.880		1.120	2.880	1.320	2.060	2.000	4	1.000	4.000	3.74
	33.40	149.3		28.40	73.15	33.50	52.30	50.80		25.40	101.6	
1 1/4	1.660	6.250		1.120	2.880	1.660	2.500	2.500	4	1.000	4.380	4.33
	42.20	158.7		28.40	73.15	42.20	63.50	63.50		25.40	111.2	
1 1/2	1.900	7.000		1.250	3.250	1.900	2.750	2.880	4	1.120	4.880	5.94
	48.30	177.8		31.70	82.50	48.30	69.85	73.15		28.40	123.9	
2	2.375	8.500		1.500	4.000	2.380	4.120	3.620	8	1.000	6.500	10.8
	60.30	215.9		38.10	101.6	60.45	104.6	91.90		25.40	165.1	
2 1/2	2.875	9.620		1.620	4.120	2.880	4.880	4.120	8	1.120	7.500	15.0
	73.00	244.3		41.10	104.6	73.15	123.9	104.6		28.40	190.5	
3	3.500	9.500		1.500	4.000	3.500	5.000	5.000	8	1.000	7.500	13.7
	88.90	241.3		38.10	101.6	88.90	127.0	127.0		25.40	190.5	
4	4.500	11.50		1.750	4.500	4.500	6.250	6.190	8	1.250	9.250	22.5
	114.3	292.1		44.40	114.3	114.3	158.7	157.2		31.70	234.9	
5	5.563	13.75		2.000	5.000	5.560	7.500	7.310	8	1.380	11.00	37.4
	141.3	349.2		50.80	127.0	141.2	190.5	185.7		35.00	279.4	
6	6.625	15.00	2.190	5.500	6.630	9.250	8.500	12	1.250	12.50	47.7	
	168.3	381.0	55.60	139.7	168.4	234.9	215.9		31.70	317.5		
8	8.625	18.50	2.500	6.380	8.630	11.75	10.62	12	1.500	15.50	81.3	
	219.1	469.9	63.50	162.0	219.2	298.4	269.7		38.10	393.7		
10	10.75	21.50	2.750	7.250	10.75	14.50	12.75	16	1.500	18.50	119	
	273.0	546.1	69.85	184.1	273.0	368.3	323.8		38.10	469.9		
12	12.75	24.00	3.120	7.880	12.75	16.50	15.00	20	1.500	21.00	157	
	323.8	609.6	79.25	200.1	323.8	419.1	381.0		38.10	533.4		
14	14.00	25.25	3.380	8.380	14.00	17.75	16.25	20	1.620	22.00	180	
	355.6	641.3	85.80	212.8	355.6	450.8	412.7		41.10	558.8		
16	16.00	27.75	3.500	8.500	16.00	20.00	18.50	20	1.750	24.25	217	
	406.4	704.8	88.90	215.9	406.4	508.0	469.9		44.40	615.9		
18	18.00	31.00	4.000	9.000	18.00	22.25	21.00	20	2.000	27.00	292	
	457.2	787.4	101.6	228.6	457.2	565.1	533.4		50.80	685.8		
20	20.00	33.75	4.250	9.750	20.00	24.50	23.00	20	2.120	29.50	362	
	508.0	857.2	107.9	247.6	508.0	622.3	584.2		53.80	749.3		
24	24.00	41.00	5.500	11.50	24.00	29.50	27.25	20	2.620	35.50	665	
	609.6	1041.4	139.7	292.1	609.6	749.3	692.1		66.55	901.7		

Notes

- Dimension B corresponds to the pipe inside diameter. Values quoted assume 40S/Standard wall thickness.
- Weights are based on manufacturer's data and are approximate.
- For ring joint facings see page 8-6. For weld end bevel see page 8-5.
- For tolerances see page 8-4.

Weld Neck Flanges - ANSI B16.5

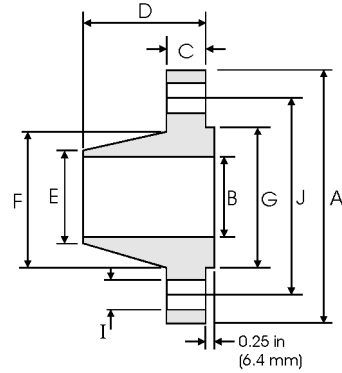

Class 1500 lb

Nominal Pipe Size	Pipe		Flange Data				Hub Data		Raised Face	Drilling Data			Weight
	Outside Diameter	Overall Diameter	A	B	C	D	E	F	G	H	I	J	kg/ piece
1/2	0.840	4.750	To be specified by Purchaser	0.880	2.380	0.840	1.500	1.380	4	0.880	3.250	1.87	
	21.30	120.6		22.30	60.45	21.30	38.10	35.00		22.30	82.50		
3/4	1.050	5.120		1.000	2.750	1.050	1.750	1.690	4	0.880	3.500	2.56	
	26.70	130.0		25.40	69.85	26.70	44.00	42.90		22.30	88.90		
1	1.315	5.880		1.120	2.880	1.320	2.060	2.000	4	1.000	4.000	3.74	
	33.40	149.3		28.40	73.15	33.50	52.30	50.80		25.40	101.6		
1 1/4	1.660	6.250		1.120	2.880	1.660	2.500	2.500	4	1.000	4.380	4.33	
	42.20	158.7		28.40	73.15	42.20	63.50	63.50		25.40	111.2		
1 1/2	1.900	7.000		1.250	3.250	1.900	2.750	2.880	4	1.120	4.880	5.94	
	48.30	177.8		31.70	82.50	48.30	69.85	73.15		28.40	123.9		
2	2.375	8.500		1.500	4.000	2.380	4.120	3.620	8	1.000	6.500	10.8	
	60.30	215.9		38.10	101.6	60.45	104.6	91.90		25.40	165.1		
2 1/2	2.875	9.620		1.620	4.120	2.880	4.880	4.120	8	1.120	7.500	15.0	
	73.00	244.3		41.10	104.6	73.15	123.9	104.6		28.40	190.5		
3	3.500	10.50		1.880	4.620	3.500	5.250	5.000	8	1.250	8.000	19.9	
	88.90	266.7		47.70	177.3	88.90	133.3	127.0		31.70	203.2		
4	4.500	12.25		2.120	4.880	4.500	6.380	6.190	8	1.380	9.500	29.9	
	114.3	311.1		53.80	123.9	114.3	162.0	157.2		35.00	241.3		
5	5.563	14.75		2.880	6.120	5.560	7.750	7.310	8	1.620	11.50	55.4	
	141.3	374.6		73.15	155.4	141.2	196.8	185.7		41.10	292.1		
6	6.625	15.50	3.250	6.750	6.630	9.000	8.500	12	1.500	12.50	68.4		
	168.3	393.7	82.50	171.4	168.4	228.6	215.9		38.10	317.5			
8	8.625	19.00	3.620	8.380	8.630	11.50	10.62	12	1.750	15.50	117		
	219.1	482.6	91.90	212.8	219.2	292.1	269.7		44.40	393.7			
10	10.75	23.00	4.250	10.00	10.75	14.50	12.75	12	2.000	19.00	194		
	273.0	584.2	107.9	254.0	273.0	368.3	323.8		50.80	482.6			
12	12.75	26.50	4.880	11.12	12.75	17.75	15.00	16	2.120	22.50	288		
	323.8	673.1	123.9	282.4	323.8	450.8	381.0		53.80	571.5			
14	14.00	29.50	5.250	11.75	14.00	19.50	16.25	16	2.380	25.00	380		
	355.6	749.3	133.3	298.4	355.6	495.3	412.7		60.45	635.0			
16	16.00	32.50	5.750	12.25	16.00	21.75	18.50	16	2.620	27.75	485		
	406.4	825.5	146.0	311.1	406.4	552.4	469.9		66.55	704.8			
18	18.00	36.00	6.380	12.88	18.00	23.50	21.00	16	2.880	30.50	644		
	457.2	914.4	162.0	327.1	457.2	596.9	533.4		73.15	774.7			
20	20.00	38.75	7.000	14.00	20.00	25.25	23.00	16	3.120	32.75	775		
	508.0	984.2	177.8	355.6	508.0	641.3	584.2		79.25	831.8			
24	24.00	46.00	8.000	16.00	24.00	30.00	27.25	16	3.620	39.00	1232		
	609.6	1168.4	203.2	406.4	609.6	762.0	692.1		91.90	990.6			



Notes

- Dimension B corresponds to the pipe inside diameter. Values quoted assume 40S/Standard wall thickness.
- Weights are based on manufacturer's data and are approximate.
- For ring joint facings see page 8-6. For weld end bevel see page 8-5.
- For tolerances see page 8-4.

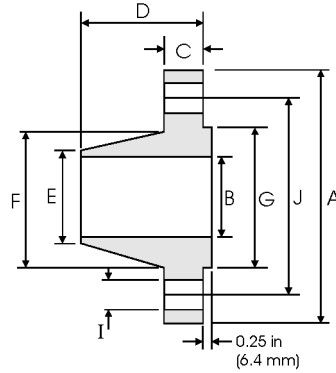
Weld Neck Flanges - ANSI B16.5



Class 2500 lb

Nominal Pipe Size	Pipe		Flange Data				Hub Data		Raised Face	Drilling Data			Weight
		A	B	C	D	E	F	G	H	I	J		
	Outside Diameter	Overall Diameter	Inside Diameter	Flange Thickness min	Overall Length	Diameter at Weld Bevel	Hub Diameter	Face Diameter	Number of Holes	Bolt Hole Diameter	Diameter of Circle of Holes	kg/ piece	
	in mm	in mm	in mm	in mm	in mm	in mm	in mm	in mm		in mm	in mm		
1/2	0.840	5.250	To be specified by Purchaser	1.190	2.880	0.840	1.690	1.380	4	0.880	3.500	3.12	
	21.30	133.4		30.20	73.15	21.30	42.90	35.00		22.40	88.90		
3/4	1.050	5.500		1.250	3.120	1.050	2.000	1.690	4	0.880	3.750	3.70	
	26.70	139.7		31.75	79.25	26.70	50.80	42.90		22.40	95.30		
1	1.315	6.250		1.380	3.500	1.320	2.250	2.000	4	1.000	4.250	5.24	
	33.40	158.8		35.10	88.90	33.50	57.15	50.80		25.40	108.0		
1 1/4	1.660	7.250		1.500	3.750	1.660	2.880	2.500	4	1.120	5.120	7.74	
	42.20	184.2		38.10	95.30	42.20	73.15	63.50		28.40	130.0		
1 1/2	1.900	8.000		1.750	4.380	1.900	3.120	2.880	4	1.250	5.750	10.9	
	48.30	203.2		44.50	111.3	48.30	79.25	73.15		31.75	146.1		
2	2.375	9.250		2.000	5.000	2.380	3.750	3.620	8	1.120	6.750	16.2	
	60.30	235.0		50.80	127.0	60.45	95.30	91.90		28.40	171.5		
2 1/2	2.875	10.50	2.250	5.620	2.880	4.500	4.120	8	1.250	7.750	23.7		
	73.00	266.7	57.15	142.7	73.15	114.3	104.6		31.75	196.9			
3	3.500	12.00	2.620	6.620	3.500	5.250	5.000	8	1.380	9.000	36.2		
	88.90	304.8	66.55	168.1	88.90	133.4	127.0		35.10	228.6			
4	4.500	14.00	3.000	7.500	4.500	6.500	6.190	8	1.620	10.75	55.3		
	114.3	355.6	76.20	190.5	114.3	165.1	157.2		41.10	273.1			
5	5.563	16.50	3.620	9.000	5.560	8.000	7.310	8	1.880	12.75	92.5		
	141.3	419.1	91.90	228.6	141.2	203.2	185.7		47.80	323.9			
6	6.625	19.00	4.250	10.75	6.630	9.250	8.500	8	2.120	14.50	143		
	168.3	482.6	108.0	273.1	168.4	235.0	215.9		53.80	368.3			
8	8.625	21.75	5.000	12.50	8.630	12.00	10.62	12	2.120	17.25	215		
	219.1	552.5	127.0	317.5	219.2	304.8	269.7		53.80	438.2			
10	10.75	26.50	6.500	16.50	10.75	14.75	12.75	12	2.620	21.25	406		
	273.0	673.1	165.1	419.1	273.0	374.7	323.8		66.55	539.8			
12	12.75	30.00	7.250	18.25	12.75	17.38	15.00	12	2.880	24.38	572		
	323.8	762.0	184.2	463.6	323.8	441.5	381.0		73.15	619.3			

Notes

- Dimension B corresponds to the pipe inside diameter. Values quoted assume 40S/Standard wall thickness.
- Weights are based on manufacturer's data and are approximate.
- For ring joint facings see page 8-6. For weld end bevel see page 8-5.
- For tolerances see page 8-4.

Slip On Flanges - ANSI B16.5

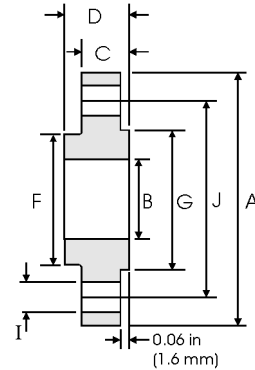

Class 150 lb

Nominal Pipe Size	Pipe		Flange Data				Hub	Raised Face	Drilling Data			Weight
		A	B	C	D	F	G	H	I	J		
	Outside Diameter	Overall Diameter	Inside Diameter	Flange Thickness min	Overall Length	Hub Diameter	Face Diameter	Number of Holes	Bolt Hole Diameter	Diameter of Circle of Holes	kg/ piece	
	in mm	in mm	in mm	in mm	in mm	in mm	in mm		in mm	in mm		
1/2	0.840	3.500	0.880	0.440	0.620	1.190	1.380	4	0.620	2.380	0.39	
	21.30	88.90	22.40	11.20	15.70	30.20	35.10		15.70	60.45		
3/4	1.050	3.880	1.090	0.500	0.620	1.500	1.690	4	0.620	2.750	0.56	
	26.70	98.60	27.70	12.70	15.70	38.10	42.90		15.70	69.85		
1	1.315	4.250	1.360	0.560	0.690	1.940	2.000	4	0.620	3.120	0.78	
	33.40	108.0	34.50	14.20	17.50	49.30	50.80		15.70	79.25		
1 1/4	1.660	4.620	1.700	0.620	0.810	2.310	2.500	4	0.620	3.500	1.03	
	42.20	117.3	43.20	15.70	20.60	58.70	63.50		15.70	88.90		
1 1/2	1.900	5.000	1.950	0.690	0.880	2.560	2.880	4	0.620	3.880	1.32	
	48.30	127.0	49.50	17.50	22.40	65.00	73.15		15.70	98.60		
2	2.375	6.000	2.440	0.750	1.000	3.060	3.620	4	0.750	4.750	2.06	
	60.30	152.4	62.00	19.10	25.40	77.70	91.90		19.10	120.7		
2 1/2	2.875	7.000	2.940	0.880	1.120	3.560	4.120	4	0.750	5.500	3.28	
	73.00	177.8	74.70	22.40	28.40	90.40	104.6		19.10	139.7		
3	3.500	7.500	3.570	0.940	1.190	4.250	5.000	4	0.750	6.000	3.85	
	88.90	190.5	90.70	23.90	30.20	108.0	127.0		19.10	152.4		
3 1/2	4.000	8.500	4.070	0.940	1.250	4.810	5.500	8	0.750	7.000	4.81	
	101.6	215.9	103.4	23.90	31.75	122.2	139.7		19.10	177.8		
4	4.500	9.000	4.570	0.940	1.310	5.310	6.190	8	0.750	7.500	5.30	
	114.3	228.6	116.1	23.90	33.30	134.9	157.2		19.10	190.5		
5	5.563	10.00	5.660	0.940	1.440	6.440	7.310	8	0.880	8.500	6.07	
	141.3	254.0	143.8	23.90	36.60	163.6	185.7		22.40	215.9		
6	6.625	11.00	6.720	1.000	1.560	7.560	8.500	8	0.880	9.500	7.45	
	168.3	279.4	170.7	25.40	39.60	192.0	215.9		22.40	241.3		
8	8.625	13.50	8.720	1.120	1.750	9.690	10.62	8	0.880	11.75	12.1	
	219.1	342.9	221.5	28.40	44.50	246.1	269.7		22.40	298.5		
10	10.75	16.00	10.88	1.190	1.940	12.00	12.75	12	1.000	14.25	16.5	
	273.0	406.4	276.3	30.20	49.30	304.8	323.9		25.40	362.0		
12	12.75	19.00	12.88	1.250	2.190	14.38	15.00	12	1.000	17.00	26.2	
	323.8	482.6	327.1	31.75	55.60	365.3	381.0		25.40	431.8		
14	14.00	21.00	14.14	1.380	2.250	15.75	16.25	12	1.120	18.75	34.6	
	355.6	533.4	359.1	35.10	57.15	400.1	412.8		28.40	476.3		
16	16.00	23.50	16.16	1.440	2.500	18.00	18.50	16	1.120	21.25	44.8	
	406.4	596.9	410.5	36.60	63.50	457.2	469.9		28.40	539.8		
18	18.00	25.00	18.18	1.560	2.690	19.88	21.00	16	1.250	22.75	48.9	
	457.2	635.0	461.8	39.60	68.30	505.0	533.4		31.75	577.9		
20	20.00	27.50	20.20	1.690	2.880	22.00	23.00	20	1.250	25.00	61.9	
	508.0	698.5	513.1	42.90	73.15	558.8	584.2		31.75	635.0		
24	24.00	32.00	24.25	1.880	3.250	26.12	27.25	20	1.380	29.50	86.9	
	609.6	812.8	616.0	47.80	82.60	663.4	692.2		35.10	749.3		

Notes

- Weights are based on manufacturer's data and are approximate.
- Flat face flanges may be provided at full thickness, C, or with raised face removed (the latter is nonstandard).
- For ring joint facings see page 8-6.
- For tolerances see page 8-4.

Slip On Flanges - ANSI B16.5

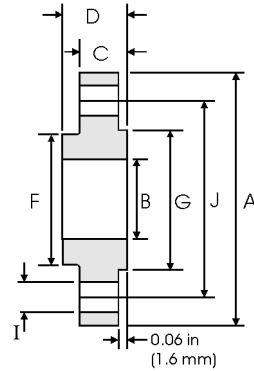

Class 300 lb

Nominal Pipe Size	Pipe	Flange Data				Hub	Raised Face	Drilling Data			Weight
		A	B	C	D	F	G	H	I	J	
	Outside Diameter	Overall Diameter	Inside Diameter	Flange Thickness min	Overall Length	Hub Diameter	Face Diameter	Number of Holes	Bolt Hole Diameter	Diameter of Circle of Holes	kg/ piece
	in mm	in mm	in mm	in mm	in mm	in mm	in mm		in mm	in mm	
1/2	0.840	3.750	0.880	0.560	0.880	1.500	1.380	4	0.620	2.620	0.64
	21.30	95.20	22.40	14.20	22.40	38.10	35.10		15.70	66.55	
3/4	1.050	4.620	1.090	0.620	1.000	1.880	1.690	4	0.750	3.250	1.12
	26.70	117.3	27.70	15.70	25.40	47.70	42.90		19.10	82.50	
1	1.315	4.880	1.360	0.690	1.060	2.120	2.000	4	0.750	3.500	1.36
	33.40	123.9	34.50	17.50	26.90	53.80	50.80		19.10	88.90	
1 1/4	1.660	5.250	1.700	0.750	1.060	2.500	2.500	4	0.750	3.880	1.68
	42.20	133.3	43.20	19.00	26.90	63.50	63.50		19.10	98.60	
1 1/2	1.900	6.120	1.950	0.810	1.190	2.750	2.880	4	0.880	4.500	2.49
	48.30	155.4	49.50	20.60	30.20	69.85	73.15		22.40	114.3	
2	2.375	6.500	2.440	0.880	1.310	3.310	3.620	8	0.750	5.000	2.87
	60.30	165.1	62.00	22.30	33.20	84.00	91.90		19.10	127.0	
2 1/2	2.875	7.500	2.940	1.000	1.500	3.940	4.120	8	0.880	5.880	4.32
	73.00	190.5	74.70	25.40	38.10	100.0	104.6		22.40	149.4	
3	3.500	8.250	3.570	1.120	1.690	4.620	5.000	8	0.880	6.620	5.85
	88.90	209.5	90.70	28.40	42.90	117.3	127.0		22.40	168.1	
3 1/2	4.000	9.000	4.070	1.190	1.750	5.250	5.500	8	0.880	7.250	7.34
	101.6	228.6	103.4	30.20	44.40	133.3	139.7		22.40	184.2	
4	4.500	10.00	4.570	1.250	1.880	5.750	6.190	8	0.880	7.880	9.61
	114.3	254.0	116.1	31.70	47.70	146.0	157.2		22.40	200.1	
5	5.563	11.00	5.660	1.380	2.000	7.000	7.310	8	0.880	9.250	12.3
	141.3	279.4	143.8	35.00	50.80	177.8	185.7		22.40	234.9	
6	6.625	12.50	6.720	1.440	2.060	8.120	8.500	12	0.880	10.62	15.6
	168.3	317.5	170.7	36.50	52.30	206.2	215.9		22.40	269.7	
8	8.625	15.00	8.720	1.620	2.440	10.25	10.62	12	1.000	13.00	24.2
	219.1	381.0	221.5	41.10	61.90	260.3	269.7		25.40	330.2	
10	10.75	17.50	10.88	1.880	2.620	12.62	12.75	16	1.120	15.25	34.1
	273.0	444.5	276.3	47.70	66.55	320.5	323.9		28.40	387.3	
12	12.75	20.50	12.88	2.000	2.880	14.75	15.00	16	1.250	17.75	49.8
	323.8	520.7	327.1	50.80	73.15	374.6	381.0		31.70	450.8	
14	14.00	23.00	14.14	2.120	3.000	16.75	16.25	20	1.250	20.25	69.9
	355.6	584.2	359.1	53.80	76.20	425.4	412.8		31.70	514.4	
16	16.00	25.50	16.16	2.250	3.250	19.00	18.50	20	1.380	22.50	88.1
	406.4	647.7	410.5	57.15	82.50	482.6	469.9		35.00	571.5	
18	18.00	28.00	18.18	2.380	3.500	21.00	21.00	24	1.380	24.75	109
	457.2	711.2	461.8	60.45	88.90	533.4	533.4		35.00	628.7	
20	20.00	30.50	20.20	2.500	3.750	23.12	23.00	24	1.380	27.00	134
	508.0	774.7	513.1	63.50	95.20	587.2	584.2		35.00	685.8	
24	24.00	36.00	24.25	2.750	4.190	27.62	27.25	24	1.620	32.00	201
	609.6	914.4	616.0	69.85	106.4	701.5	692.2		41.00	812.8	

Notes

- Weights are based on manufacturer's data and are approximate.
- Flat face flanges may be provided at full thickness, C, or with raised face removed (the latter is nonstandard).
- For ring joint facings see page 8-6.
- For tolerances see page 8-4.

Slip On Flanges - ANSI B16.5

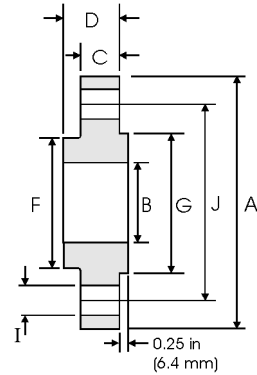

Class 400 lb

Pipe		Flange Data				Hub	Raised Face	Drilling Data			Weight
Nominal Pipe Size		A	B	C	D	F	G	H	I	J	
	Outside Diameter	Overall Diameter	Inside Diameter	Flange Thickness min	Overall Length	Hub Diameter	Face Diameter	Number of Holes	Bolt Hole Diameter	Diameter of Circle of Holes	kg/ piece
	in mm	in mm	in mm	in mm	in mm	in mm	in mm		in mm	in mm	
1/2	0.840	3.750	0.880	0.560	0.880	1.500	1.380	4	0.620	2.620	0.74
	21.30	95.30	22.40	14.20	22.40	38.10	35.10		15.70	66.55	
3/4	1.050	4.620	1.090	0.620	1.000	1.880	1.690	4	0.750	3.250	1.27
	26.70	117.3	27.70	15.70	25.40	47.70	42.90		19.10	82.50	
1	1.315	4.880	1.360	0.690	1.060	2.120	2.000	4	0.750	3.500	1.52
	33.40	124.0	34.50	17.50	26.90	53.80	50.80		19.10	88.90	
1 1/4	1.660	5.250	1.700	0.810	1.120	2.500	2.500	4	0.750	3.880	2.03
	42.20	133.4	43.20	20.60	28.40	63.50	63.50		19.10	98.60	
1 1/2	1.900	6.120	1.950	0.880	1.250	2.750	2.880	4	0.880	4.500	2.96
	48.30	155.4	49.50	22.40	31.75	69.85	73.15		22.40	114.3	
2	2.375	6.500	2.440	1.000	1.440	3.310	3.620	8	0.750	5.000	3.62
	60.30	165.1	62.00	25.40	36.60	84.00	91.90		19.10	127.0	
2 1/2	2.875	7.500	2.940	1.120	1.620	3.940	4.120	8	0.880	5.880	5.28
	73.00	190.5	74.70	28.40	41.10	100.0	104.6		22.40	149.4	
3	3.500	8.250	3.570	1.250	1.810	4.620	5.000	8	0.880	6.620	7.00
	88.90	209.6	90.70	31.75	46.00	117.3	127.0		22.40	168.1	
3 1/2	4.000	9.000	4.070	1.380	1.940	5.250	5.500	8	1.000	7.250	8.84
	101.6	228.6	103.4	35.10	49.30	133.3	139.7		25.40	184.2	
4	4.500	10.00	4.570	1.380	2.000	5.750	6.190	8	1.000	7.880	11.1
	114.3	254.0	116.1	35.10	50.80	146.0	157.2		25.40	200.1	
5	5.563	11.00	5.660	1.500	2.120	7.000	7.310	8	1.000	9.250	13.9
	141.3	279.4	143.8	38.10	53.80	177.8	185.7		25.40	234.9	
6	6.625	12.50	6.720	1.620	2.250	8.120	8.500	12	1.000	10.62	18.3
	168.3	317.5	170.7	41.10	57.15	206.2	215.9		25.40	269.7	
8	8.625	15.00	8.720	1.880	2.690	10.25	10.62	12	1.120	13.00	28.6
	219.1	381.0	221.5	47.80	68.30	260.3	269.7		28.40	330.2	
10	10.75	17.50	10.88	2.120	2.880	12.62	12.75	16	1.250	15.25	39.2
	273.0	444.5	276.3	53.80	73.15	320.5	323.9		31.75	387.3	
12	12.75	20.50	12.88	2.250	3.120	14.75	15.00	16	1.380	17.75	57.0
	323.8	520.7	327.1	57.15	79.25	374.6	381.0		35.10	450.8	
14	14.00	23.00	14.14	2.380	3.310	16.75	16.25	20	1.380	20.25	79.1
	355.6	584.2	359.1	60.05	84.10	425.4	412.8		35.10	514.4	
16	16.00	25.50	16.16	2.500	3.690	19.00	18.50	20	1.500	22.50	101
	406.4	647.7	410.5	63.50	93.70	482.6	469.9		38.10	571.5	
18	18.00	28.00	18.18	2.620	3.880	21.00	21.00	24	1.500	24.75	123
	457.2	711.2	461.8	66.55	98.60	533.4	533.4		38.10	628.7	
20	20.00	30.50	20.20	2.750	4.000	23.12	23.00	24	1.620	27.00	146
	508.0	774.7	513.1	69.85	101.6	587.2	584.2		41.10	685.8	
24	24.00	36.00	24.25	3.000	4.500	27.62	27.25	24	1.880	32.00	219
	609.6	914.4	616.0	76.20	114.3	701.5	692.2		47.80	812.8	

Notes

- Weights are based on manufacturer's data and are approximate.
- For ring joint facings see page 8-6.
- For tolerances see page 8-4.

Slip On Flanges - ANSI B16.5

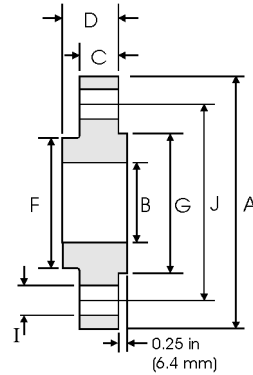

Class 600 lb

Nominal Pipe Size	Pipe	Flange Data				Hub	Raised Face	Drilling Data			Weight
		A	B	C	D	F	G	H	I	J	
	Outside Diameter	Overall Diameter	Inside Diameter	Flange Thickness min	Overall Length	Hub Diameter	Face Diameter	Number of Holes	Bolt Hole Diameter	Diameter of Circle of Holes	kg/ piece
	in mm	in mm	in mm	in mm	in mm	in mm	in mm		in mm	in mm	
1/2	0.840	3.750	0.880	0.560	0.880	1.500	1.380	4	0.620	2.620	0.74
	21.30	95.30	22.40	14.20	22.40	38.10	35.10		15.70	66.55	
3/4	1.050	4.620	1.090	0.620	1.000	1.880	1.690	4	0.750	3.250	1.27
	26.70	117.3	27.70	15.70	25.40	47.80	42.90		19.10	82.60	
1	1.315	4.880	1.360	0.690	1.060	2.120	2.000	4	0.750	3.500	1.52
	33.40	124.0	34.50	17.50	26.90	53.80	50.80		19.10	88.90	
1 1/4	1.660	5.250	1.700	0.810	1.120	2.500	2.500	4	0.750	3.880	2.03
	42.20	133.4	43.20	20.60	28.40	63.50	63.50		19.10	98.60	
1 1/2	1.900	6.120	1.950	0.880	1.250	2.750	2.880	4	0.880	4.500	2.96
	48.30	155.4	49.50	22.40	31.75	69.85	73.15		22.40	114.3	
2	2.375	6.500	2.440	1.000	1.440	3.310	3.620	8	0.750	5.000	3.62
	60.30	165.1	62.00	25.40	36.60	84.10	91.90		19.10	127.0	
2 1/2	2.875	7.500	2.940	1.120	1.620	3.940	4.120	8	0.880	5.880	5.28
	73.00	190.5	74.70	28.40	41.10	100.1	104.6		22.40	149.4	
3	3.500	8.250	3.570	1.250	1.810	4.620	5.000	8	0.880	6.620	7.00
	88.90	209.6	90.70	31.75	46.00	117.3	127.0		22.40	168.1	
3 1/2	4.000	9.000	4.070	1.380	1.940	5.250	5.500	8	1.000	7.250	8.84
	101.6	228.6	103.4	35.10	49.30	133.4	139.7		25.40	184.2	
4	4.500	10.75	4.570	1.500	2.120	6.000	6.190	8	1.000	8.500	14.5
	114.3	273.1	116.1	38.10	53.80	152.4	157.2		25.40	215.9	
5	5.563	13.00	5.660	1.750	2.380	7.440	7.310	8	1.120	10.50	24.4
	141.3	330.2	143.8	44.50	60.45	189.0	185.7		28.40	266.7	
6	6.625	14.00	6.720	1.880	2.620	8.750	8.500	12	1.120	11.50	28.7
	168.3	355.6	170.7	47.80	66.55	222.3	215.9		28.40	292.1	
8	8.625	16.50	8.720	2.190	3.000	10.75	10.62	12	1.250	13.75	43.4
	219.1	419.1	221.5	55.60	76.20	273.1	269.7		31.75	349.3	
10	10.75	20.00	10.88	2.500	3.380	13.50	12.75	16	1.380	17.00	70.3
	273.0	508.0	276.3	63.50	85.90	342.9	323.9		35.10	431.8	
12	12.75	22.00	12.88	2.620	3.620	15.75	15.00	20	1.380	19.25	84.2
	323.8	558.8	327.1	66.55	91.90	400.1	381.0		35.10	489.0	
14	14.00	23.75	14.14	2.750	3.690	17.00	16.25	20	1.500	20.75	98.7
	355.6	603.3	359.1	69.85	93.70	431.8	412.8		38.10	527.1	
16	16.00	27.00	16.16	3.000	4.190	19.50	18.50	20	1.620	23.75	142
	406.4	685.8	410.5	76.20	106.4	495.3	469.9		41.10	603.3	
18	18.00	29.25	18.18	3.250	4.620	21.50	21.00	20	1.750	25.75	173
	457.2	743.0	461.8	82.60	117.3	546.1	533.4		44.50	654.1	
20	20.00	32.00	20.20	3.500	5.000	24.00	23.00	24	1.750	28.50	220
	508.0	812.8	513.1	88.90	127.0	609.6	584.2		44.50	723.9	
24	24.00	37.00	24.25	4.000	5.500	28.25	27.25	24	2.000	33.00	312
	609.6	939.8	616.0	101.6	139.7	717.6	692.2		50.80	838.2	

Notes

- Weights are based on manufacturer's data and are approximate.
- For ring joint facings see page 8-6.
- For tolerances see page 8-4.

Slip On Flanges - ANSI B16.5

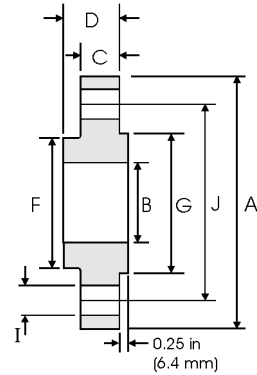

Class 900 lb

Pipe		Flange Data				Hub	Raised Face	Drilling Data			Weight
Nominal Pipe Size		A	B	C	D	F	G	H	I	J	
	Outside Diameter	Overall Diameter	Inside Diameter	Flange Thickness min	Overall Length	Hub Diameter	Face Diameter	Number of Holes	Bolt Hole Diameter	Diameter of Circle of Holes	kg/ piece
	in mm	in mm	in mm	in mm	in mm	in mm	in mm		in mm	in mm	
1/2	0.840 21.30	4.750 120.6	0.880 22.40	0.880 22.40	1.250 31.70	1.500 38.10	1.380 35.10	4	0.880 22.40	3.250 82.50	1.74
3/4	1.050 26.70	5.120 130.0	1.090 27.70	1.000 25.40	1.380 35.00	1.750 44.40	1.690 42.90	4	0.880 22.40	3.500 88.90	2.34
1	1.315 33.40	5.880 149.3	1.360 34.50	1.120 28.40	1.620 41.10	2.060 52.30	2.000 50.80	4	1.000 25.40	4.000 101.6	3.44
1 1/4	1.660 42.20	6.250 158.7	1.700 43.20	1.120 28.40	1.620 41.10	2.500 63.50	2.500 63.50	4	1.000 25.40	4.380 111.2	3.91
1 1/2	1.900 48.30	7.000 177.8	1.950 49.50	1.250 31.70	1.750 44.50	2.750 69.85	2.880 73.15	4	1.120 28.40	4.880 123.9	5.36
2	2.375 60.30	8.500 215.9	2.440 62.00	1.500 38.10	2.250 57.15	4.120 104.6	3.620 91.90	8	1.000 25.40	6.500 165.1	9.85
2 1/2	2.875 73.00	9.620 244.3	2.940 74.70	1.620 41.10	2.500 63.50	4.880 123.9	4.120 104.6	8	1.120 28.40	7.500 190.5	13.7
3	3.500 88.90	9.500 241.3	3.570 90.70	1.500 38.10	2.120 53.80	5.000 127.0	5.000 127.0	8	1.000 25.40	7.500 190.5	11.6
4	4.500 114.3	11.50 292.1	4.570 116.1	1.750 44.40	2.750 69.85	6.250 158.7	6.190 157.2	8	1.250 31.70	9.250 234.9	19.7
5	5.563 141.3	13.75 349.2	5.660 143.8	2.000 50.80	3.120 79.25	7.500 190.5	7.310 185.7	8	1.380 35.00	11.00 279.4	31.9
6	6.625 168.3	15.00 381.0	6.720 170.7	2.190 55.60	3.380 85.80	9.250 234.9	8.500 215.9	12	1.250 31.70	12.50 317.5	41.1
8	8.625 219.1	18.50 469.9	8.720 221.5	2.500 63.50	4.000 101.6	11.75 298.4	10.62 269.7	12	1.500 38.10	15.50 393.7	70.7
10	10.75 273.0	21.50 546.1	10.88 276.3	2.750 69.85	4.250 107.9	14.50 368.3	12.75 323.9	16	1.500 38.10	18.50 469.9	101
12	12.75 323.8	24.00 609.6	12.88 327.1	3.120 79.25	4.620 117.3	16.50 419.1	15.00 381.0	20	1.500 38.10	21.00 533.4	133
14	14.00 355.6	25.25 641.3	14.14 359.1	3.380 85.80	5.120 130.0	17.75 450.8	16.25 412.8	20	1.620 41.10	22.00 558.8	153
16	16.00 406.4	27.75 704.8	16.16 410.5	3.500 88.90	5.250 133.3	20.00 508.0	18.50 469.9	20	1.750 44.40	24.25 615.9	185
18	18.00 457.2	31.00 787.4	18.18 461.8	4.000 101.6	6.000 152.4	22.25 565.1	21.00 533.4	20	2.000 50.80	27.00 685.8	258
20	20.00 508.0	33.75 857.2	20.20 513.1	4.250 107.9	6.250 158.7	24.50 622.3	23.00 584.2	20	2.120 53.80	29.50 749.3	317
24	24.00 609.6	41.00 1041.4	24.25 616.0	5.500 139.7	8.000 203.2	29.50 749.3	27.25 692.2	20	2.620 66.55	35.50 901.7	606



Notes

- Weights are based on manufacturer's data and are approximate.
- For ring joint facings see page 8-6.
- For tolerances see page 8-4.

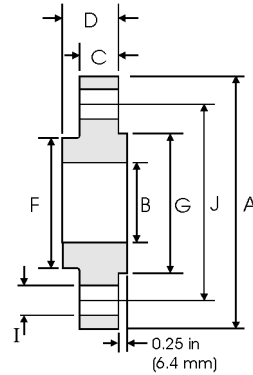
Slip On Flanges - ANSI B16.5



Class 1500 lb

Pipe		Flange Data				Hub	Raised Face	Drilling Data			Weight
Nominal Pipe Size		A	B	C	D	F	G	H	I	J	
	Outside Diameter	Overall Diameter	Inside Diameter	Flange Thickness min	Overall Length	Hub Diameter	Face Diameter	Number of Holes	Bolt Hole Diameter	Diameter of Circle of Holes	kg/ piece
	in mm	in mm	in mm	in mm	in mm	in mm	in mm		in mm	in mm	
1/2	0.840	4.750	0.880	0.880	1.250	1.500	1.380	4	0.880	3.250	1.74
	21.30	120.6	22.40	22.40	31.70	38.10	35.10		22.40	82.50	
3/4	1.050	5.120	1.090	1.000	1.380	1.750	1.690	4	0.880	3.500	2.34
	26.70	130.0	27.70	25.40	35.00	44.40	42.90		22.40	88.90	
1	1.315	5.880	1.360	1.120	1.620	2.060	2.000	4	1.000	4.000	3.44
	33.40	149.3	34.50	28.40	41.10	52.30	50.80		25.40	101.6	
1 1/4	1.660	6.250	1.700	1.120	1.620	2.500	2.500	4	1.000	4.380	3.91
	42.20	158.7	43.20	28.40	41.10	63.50	63.50		25.40	111.2	
1 1/2	1.900	7.000	1.950	1.250	1.750	2.750	2.880	4	1.120	4.880	5.36
	48.30	177.8	49.50	31.70	44.50	69.85	73.15		28.40	123.9	
2	2.375	8.500	2.440	1.500	2.250	4.120	3.620	8	1.000	6.500	9.85
	60.30	215.9	62.00	38.10	57.15	104.6	91.90		25.40	165.1	
2 1/2	2.875	9.620	2.940	1.620	2.500	4.880	4.120	8	1.120	7.500	13.7
	73.00	244.3	74.70	41.10	63.50	123.9	104.6		28.40	190.5	

Notes

- Weights are based on manufacturer's data and are approximate.
- For ring joint facings see page 8-6.
- For tolerances see page 8-4.

Blind Flanges - ANSI B16.5

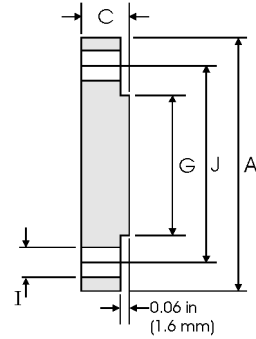
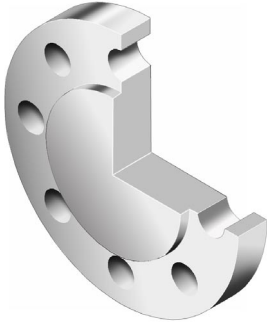

Class 150 lb

Nominal Pipe Size	Pipe	Flange Data			Raised Face	Drilling Data			Weight
		A	C	G	H	I	J		
	Outside Diameter	Overall Diameter	Flange Thickness min	Face Diameter	Number of Holes	Bolt Hole Diameter	Diameter of Circle of Holes	kg/piece	
in mm	in mm	in mm	in mm	in mm		in mm			
1/2	0.840	3.500	0.440	1.380	4	0.620	2.380	0.42	
	21.30	88.90	11.20	35.10		15.70	60.45		
3/4	1.050	3.880	0.500	1.690	4	0.620	2.750	0.61	
	26.70	98.60	12.70	42.90		15.70	69.85		
1	1.315	4.250	0.560	2.000	4	0.620	3.120	0.86	
	33.40	108.0	14.20	50.80		15.70	79.25		
1 1/4	1.660	4.620	0.620	2.500	4	0.620	3.500	1.17	
	42.20	117.3	15.70	63.50		15.70	88.90		
1 1/2	1.900	5.000	0.690	2.880	4	0.620	3.880	1.53	
	48.30	127.0	17.50	73.15		15.70	98.60		
2	2.375	6.000	0.750	3.620	4	0.750	4.750	2.42	
	60.30	152.4	19.10	91.90		19.10	120.7		
2 1/2	2.875	7.000	0.880	4.120	4	0.750	5.500	3.94	
	73.00	177.8	22.40	104.6		19.10	139.7		
3	3.500	7.500	0.940	5.000	4	0.750	6.000	4.93	
	88.90	190.5	23.90	127.0		19.10	152.4		
3 1/2	4.000	8.500	0.940	5.500	8	0.750	7.000	6.17	
	101.6	215.9	23.90	139.7		19.10	177.8		
4	4.500	9.000	0.940	6.190	8	0.750	7.500	7.00	
	114.3	228.6	23.90	157.2		19.10	190.5		
5	5.563	10.00	0.940	7.310	8	0.880	8.500	8.63	
	141.3	254.0	23.90	185.7		22.40	215.9		
6	6.625	11.00	1.000	8.500	8	0.880	9.500	11.3	
	168.3	279.4	25.40	215.9		22.40	241.3		
8	8.625	13.50	1.120	10.62	8	0.880	11.75	19.6	
	219.1	342.9	28.40	269.7		22.40	298.5		
10	10.75	16.00	1.190	12.75	12	1.000	14.25	28.8	
	273.0	406.4	30.20	323.9		25.40	362.0		
12	12.75	19.00	1.250	15.00	12	1.000	17.00	43.2	
	323.8	482.6	31.75	381.0		25.40	431.8		
14	14.00	21.00	1.380	16.25	12	1.120	18.75	58.1	
	355.6	533.4	35.10	412.8		28.40	476.3		
16	16.00	23.50	1.440	18.50	16	1.120	21.25	76.0	
	406.4	596.9	36.60	469.9		28.40	539.8		
18	18.00	25.00	1.560	21.00	16	1.250	22.75	93.7	
	457.2	635.0	39.60	533.4		31.75	577.9		
20	20.00	27.50	1.690	23.00	20	1.250	25.00	122	
	508.0	698.5	42.90	584.2		31.75	635.0		
24	24.00	32.00	1.880	27.25	20	1.380	29.50	185	
	609.6	812.8	47.80	692.2		35.10	749.3		



Notes

- Weights are based on manufacturer's data and are approximate.
- Flat face flanges may be provided at full thickness, C, or with raised face removed (the latter is nonstandard).
- For ring joint facings see page 8-6.
- For tolerances see page 8-4.

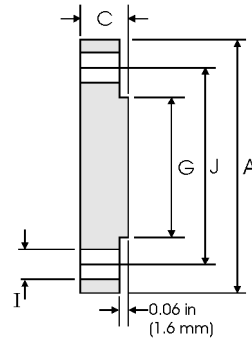
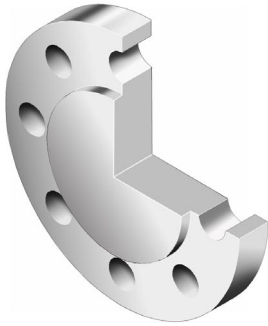
Blind Flanges - ANSI B16.5



Class 300 lb

Nominal Pipe Size	Pipe	Flange Data			Raised Face	Drilling Data		Weight
		A	C	G	H	I	J	
	Outside Diameter	Overall Diameter	Flange Thickness min	Face Diameter	Number of Holes	Bolt Hole Diameter	Diameter of Circle of Holes	kg/piece
in mm	in mm	in mm	in mm	in mm		in mm		
1/2	0.840	3.750	0.560	1.380	4	0.620	2.620	0.64
	21.30	95.20	14.20	35.10		15.70	66.55	
3/4	1.050	4.620	0.620	1.690	4	0.750	3.250	1.11
	26.70	117.3	15.70	42.90		19.00	82.50	
1	1.315	4.880	0.690	2.000	4	0.750	3.500	1.39
	33.40	123.9	17.50	50.80		19.00	88.90	
1 1/4	1.660	5.250	0.750	2.500	4	0.750	3.880	1.79
	42.20	133.3	19.00	63.50		19.00	98.50	
1 1/2	1.900	6.120	0.810	2.880	4	0.880	4.500	2.66
	48.30	155.4	20.60	73.15		22.3	114.3	
2	2.375	6.500	0.880	3.620	8	0.750	5.000	3.18
	60.30	165.1	22.30	91.90		19.10	127.0	
2 1/2	2.875	7.500	1.000	4.120	8	0.880	5.880	4.85
	73.00	190.5	25.40	104.6		22.30	1.493	
3	3.500	8.250	1.120	5.000	8	0.880	6.620	6.81
	88.90	209.5	28.40	127.0		22.30	168.1	
3 1/2	4.000	9.000	1.190	5.500	8	0.880	7.250	8.71
	101.6	228.6	30.20	139.7		22.30	184.1	
4	4.500	10.00	1.250	6.190	8	0.880	7.800	11.5
	114.3	254.0	31.70	157.2		22.30	200.1	
5	5.563	11.00	1.380	7.310	8	0.880	9.250	15.6
	141.3	279.4	35.00	185.7		22.30	234.9	
6	6.625	12.50	1.440	8.500	12	0.880	10.62	20.9
	168.3	317.5	36.50	215.9		22.30	269.7	
8	8.625	15.00	1.620	10.62	12	1.000	13.00	34.3
	219.1	381.0	41.10	269.7		25.40	330.2	
10	10.75	17.50	1.880	12.75	16	1.120	15.25	53.3
	273.0	444.5	47.70	323.9		28.40	387.3	
12	12.75	20.50	2.000	15.00	16	1.250	17.75	78.8
	323.8	520.7	50.80	381.0		31.70	450.8	
14	14.00	23.00	2.120	16.25	20	1.250	20.25	105
	355.6	584.2	53.80	412.8		31.70	514.3	
16	16.00	25.50	2.250	18.50	20	1.380	22.50	137
	406.4	647.7	57.15	469.9		35.00	571.5	
18	18.00	28.00	2.380	21.00	24	1.380	24.75	175
	457.2	711.2	60.45	533.4		35.00	628.6	
20	20.00	30.50	2.500	23.00	24	1.380	27.00	221
	508.0	774.7	63.50	584.2		35.00	685.8	
24	24.00	36.00	2.750	27.25	24	1.620	32.00	339
	609.6	914.4	69.85	692.2		41.10	812.8	



Notes

- Weights are based on manufacturer's data and are approximate.
- Flat face flanges may be provided at full thickness, C, or with raised face removed (the latter is nonstandard).
- For ring joint facings see page 8-6.
- For tolerances see page 8-4.

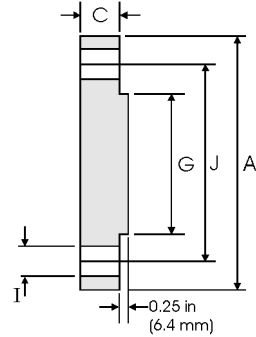
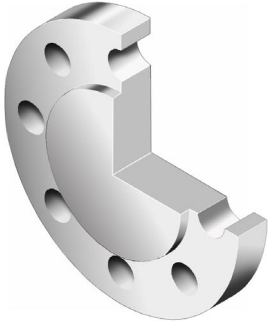
Blind Flanges - ANSI B16.5



Class 400 lb

Pipe		Flange Data			Raised Face	Drilling Data			Weight
Nominal Pipe Size		A	C	G	H	I	J		
	Outside Diameter	Overall Diameter	Flange Thickness min	Face Diameter	Number of Holes	Bolt Hole Diameter	Diameter of Circle of Holes	kg/piece	
	in mm	in mm	in mm	in mm		in mm	in mm		
1/2	0.840	3.750	0.560	1.380	4	0.620	2.620	0.76	
	21.30	95.20	14.20	35.10		15.70	66.55		
3/4	1.050	4.620	0.620	1.690	4	0.750	3.250	1.28	
	26.70	117.3	15.70	42.90		19.10	82.60		
1	1.315	4.880	0.690	2.000	4	0.750	3.500	1.60	
	33.40	123.9	17.50	50.80		19.10	88.90		
1 1/4	1.660	5.250	0.810	2.500	4	0.750	3.880	2.23	
	42.20	133.3	20.60	63.50		19.10	98.60		
1 1/2	1.900	6.120	0.880	2.880	4	0.880	4.500	3.25	
	48.30	155.4	22.30	73.15		22.40	114.3		
2	2.375	6.500	1.000	3.620	8	0.750	5.000	4.15	
	60.30	165.1	25.40	91.90		19.10	127.0		
2 1/2	2.875	7.500	1.120	4.120	8	0.880	5.880	6.13	
	73.00	190.5	28.40	104.6		22.40	149.4		
3	3.500	8.250	1.250	5.000	8	0.880	6.620	8.44	
	88.90	209.5	31.70	127.0		22.40	168.1		
3 1/2	4.000	9.000	1.380	5.500	8	1.000	7.250	11.0	
	101.6	228.6	35.00	139.7		25.40	184.2		
4	4.500	10.00	1.380	6.190	8	1.000	7.880	13.7	
	114.3	254.0	35.10	157.2		25.40	200.2		
5	5.563	11.00	1.500	7.310	8	1.000	9.250	18.5	
	141.3	279.4	38.10	185.7		25.40	235.0		
6	6.625	12.50	1.620	8.500	12	1.000	10.62	25.5	
	168.3	317.5	41.10	215.9		25.40	269.7		
8	8.625	15.00	1.880	10.62	12	1.120	13.00	42.6	
	219.1	381.0	47.80	269.7		28.40	330.2		
10	10.75	17.50	2.120	12.75	16	1.250	15.25	64.5	
	273.0	444.5	53.80	323.9		31.75	387.4		
12	12.75	20.50	2.250	15.00	16	1.380	17.75	94.30	
	323.8	520.7	57.15	381.0		35.10	450.9		
14	14.00	23.00	2.380	16.25	20	1.380	20.25	124	
	355.6	584.2	60.45	412.8		35.10	514.4		
16	16.00	25.50	2.500	18.50	20	1.500	22.50	162	
	406.4	647.7	63.50	469.9		38.10	571.5		
18	18.00	28.00	2.620	21.00	24	1.500	24.75	205	
	457.2	711.2	66.55	533.4		38.10	628.7		
20	20.00	30.50	2.750	23.00	24	1.620	27.00	254	
	508.0	774.7	69.85	584.2		41.10	685.8		
24	24.00	36.00	3.000	27.25	24	1.880	32.00	386	
	609.6	914.4	76.20	692.2		47.80	812.8		



Notes

- Weights are based on manufacturer's data and are approximate.
- For ring joint facings see page 8-6.
- For tolerances see page 8-4.

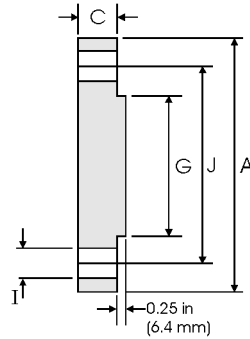
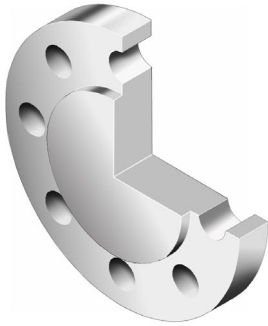
Blind Flanges - ANSI B16.5



Class 600 lb

Nominal Pipe Size	Pipe	Flange Data			Raised Face	Drilling Data		Weight
		A	C	G	H	I	J	
	Outside Diameter	Overall Diameter	Flange Thickness min	Face Diameter	Number of Holes	Bolt Hole Diameter	Diameter of Circle of Holes	kg/piece
	in mm	in mm	in mm	in mm		in mm	in mm	
1/2	0.840	3.750	0.560	1.380	4	0.620	2.620	0.76
	21.30	95.20	14.20	35.10		15.70	66.55	
3/4	1.050	4.620	0.620	1.690	4	0.750	3.250	1.28
	26.70	117.3	15.70	42.90		19.10	82.60	
1	1.315	4.880	0.690	2.000	4	0.750	3.500	1.60
	33.40	123.9	17.50	50.80		19.10	88.90	
1 1/4	1.660	5.250	0.810	2.500	4	0.750	3.880	2.23
	42.20	133.3	20.60	63.50		19.10	98.60	
1 1/2	1.900	6.120	0.880	2.880	4	0.880	4.500	3.25
	48.30	155.4	22.30	73.15		22.40	114.3	
2	2.375	6.500	1.000	3.620	8	0.750	5.000	4.15
	60.30	165.1	25.40	91.90		19.10	127.0	
2 1/2	2.875	7.500	1.120	4.120	8	0.880	5.880	6.13
	73.00	190.5	28.40	104.6		22.40	149.4	
3	3.500	8.250	1.250	5.000	8	0.880	6.620	8.44
	88.90	209.5	31.70	127.0		22.40	168.1	
3 1/2	4.000	9.000	1.380	5.500	8	1.000	7.250	11.0
	101.6	228.6	35.00	139.7		25.40	184.2	
4	4.500	10.75	1.500	6.190	8	1.000	8.500	17.3
	114.3	273.1	38.10	157.2		25.40	215.9	
5	5.563	13.00	1.750	7.310	8	1.120	10.50	29.4
	141.3	330.2	44.50	185.7		28.40	266.7	
6	6.625	14.00	1.880	8.500	12	1.120	11.50	36.1
	168.3	355.6	47.80	215.9		28.40	292.1	
8	8.625	16.50	2.190	10.62	12	1.250	13.75	58.9
	219.1	419.1	55.60	269.7		31.75	349.3	
10	10.75	20.00	2.500	12.75	16	1.380	17.00	97.5
	273.0	508.0	63.50	323.9		35.10	431.8	
12	12.75	22.00	2.620	15.00	20	1.380	19.25	124
	323.8	558.8	66.55	381.0		35.10	489.0	
14	14.00	23.75	2.750	16.25	20	1.500	20.75	151
	355.6	603.3	69.85	412.8		38.10	527.1	
16	16.00	27.00	3.000	18.50	20	1.620	23.75	214
	406.4	685.8	76.20	469.9		41.10	603.3	
18	18.00	29.25	3.250	21.00	20	1.750	25.75	272
	457.2	743.0	82.60	533.4		44.50	654.1	
20	20.00	32.00	3.500	23.00	24	1.750	28.50	349
	508.0	812.8	88.90	584.2		44.50	723.9	
24	24.00	37.00	4.000	27.25	24	2.000	33.00	533
	609.6	939.8	101.6	692.2		50.80	838.2	

Notes

- Weights are based on manufacturer's data and are approximate.
- For ring joint facings see page 8-6.
- For tolerances see page 8-4.

Blind Flanges - ANSI B16.5

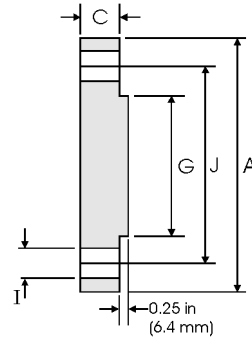
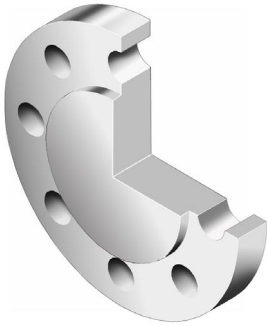

Class 900 lb

Pipe		Flange Data			Raised Face	Drilling Data			Weight
Nominal Pipe Size		A	C	G	H	I	J		
	Outside Diameter	Overall Diameter	Flange Thickness min	Face Diameter	Number of Holes	Bolt Hole Diameter	Diameter of Circle of Holes	kg/piece	
	in mm	in mm	in mm	in mm		in mm	in mm		
1/2	0.840	4.750	0.880	1.380	4	0.880	3.250	1.77	
	21.30	120.6	22.30	35.10		22.30	82.50		
3/4	1.050	5.120	1.000	1.690	4	0.880	3.500	2.42	
	26.70	130.0	25.40	42.90		22.30	88.90		
1	1.315	5.880	1.120	2.000	4	1.000	4.000	3.57	
	33.40	149.3	28.40	50.80		25.40	101.6		
1 1/4	1.660	6.250	1.120	2.500	4	1.000	4.380	4.15	
	42.20	158.7	28.40	63.50		25.40	111.2		
1 1/2	1.900	7.000	1.250	2.880	4	1.120	4.880	5.75	
	48.30	177.8	31.70	73.15		28.40	123.9		
2	2.375	8.500	1.500	3.620	8	1.000	6.500	10.1	
	60.30	215.9	38.10	91.90		25.40	165.1		
2 1/2	2.875	9.620	1.620	4.120	8	1.120	7.500	14.0	
	73.00	244.3	41.10	104.6		28.40	190.5		
3	3.500	9.500	1.500	5.000	8	1.000	7.500	13.1	
	88.90	241.3	38.10	127.0		25.40	190.5		
4	4.500	11.50	1.750	6.190	8	1.250	9.250	26.9	
	114.3	292.1	44.50	157.2		31.70	234.9		
5	5.563	13.75	2.000	7.310	8	1.380	11.00	36.5	
	141.3	349.2	50.80	185.7		35.00	279.4		
6	6.625	15.00	2.190	8.500	12	1.250	12.50	47.40	
	168.3	381.0	55.60	215.9		31.70	317.0		
8	8.625	18.50	2.500	10.62	12	1.500	15.50	82.5	
	219.1	469.9	63.50	269.7		38.10	393.7		
10	10.75	21.50	2.750	12.75	16	1.500	18.50	122	
	273.0	546.1	69.85	323.9		38.10	469.9		
12	12.75	24.00	3.120	15.00	20	1.500	21.00	173	
	323.8	609.6	79.25	381.0		38.10	533.4		
14	14.00	25.25	3.380	16.25	20	1.620	22.00	206	
	355.6	641.3	85.80	412.8		41.10	558.8		
16	16.00	27.75	3.500	18.50	20	1.750	24.25	259	
	406.4	704.8	88.90	469.9		44.40	615.9		
18	18.00	31.00	4.000	21.00	20	2.000	27.00	367	
	457.2	787.4	101.6	533.4		50.80	685.8		
20	20.00	33.75	4.250	23.00	20	2.120	29.50	463	
	508.0	857.2	107.9	584.2		53.80	749.3		
24	24.00	41.00	5.500	27.25	20	2.620	35.50	876	
	609.6	1041.4	139.7	692.2		66.55	901.7		



Notes

- Weights are based on manufacturer's data and are approximate.
- For ring joint facings see page 8-6.
- For tolerances see page 8-4.

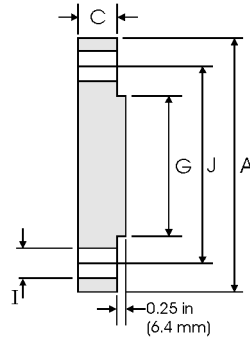
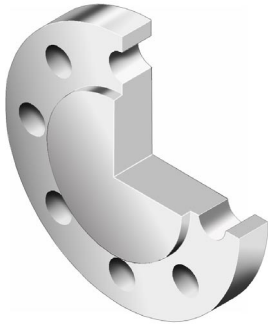
Blind Flanges - ANSI B16.5



Class 1500 lb

Nominal Pipe Size	Pipe	Flange Data		Raised Face	Drilling Data		Weight	
		A	C	G	H	I	J	
	Outside Diameter	Overall Diameter	Flange Thickness min	Face Diameter	Number of Holes	Bolt Hole Diameter	Diameter of Circle of Holes	kg/piece
	in mm	in mm	in mm	in mm		in mm	in mm	
1/2	0.840	4.750	0.880	1.380	4	0.880	3.250	1.77
	21.30	120.6	22.30	35.10		22.30	82.50	
3/4	1.050	5.120	1.000	1.690	4	0.880	3.500	2.42
	26.70	130.0	25.40	42.90		22.30	88.90	
1	1.315	5.880	1.120	2.000	4	1.000	4.000	3.57
	33.40	149.3	28.40	50.80		25.40	101.6	
1 1/4	1.660	6.250	1.120	2.500	4	1.000	4.380	4.15
	42.20	158.7	28.40	63.50		25.40	111.2	
1 1/2	1.900	7.000	1.250	2.880	4	1.120	4.880	5.75
	48.30	177.8	31.70	73.15		28.40	123.9	
2	2.375	8.500	1.500	3.620	8	1.000	6.500	10.1
	60.30	215.9	38.10	91.90		25.40	165.1	
2 1/2	2.875	9.620	1.620	4.120	8	1.120	7.500	14.0
	73.00	244.3	41.10	104.6		28.40	190.5	
3	3.500	10.50	1.880	5.000	8	1.250	8.000	19.1
	88.90	266.7	47.70	127.0		31.70	203.2	
4	4.500	12.25	2.120	6.190	8	1.380	9.500	29.9
	114.3	311.1	53.80	157.2		35.00	241.3	
5	5.563	14.75	2.880	7.310	8	1.620	11.50	58.4
	141.3	374.6	73.15	185.7		41.10	292.1	
6	6.625	15.50	3.250	8.500	12	1.500	12.50	71.8
	168.3	393.7	82.50	215.9		38.10	317.5	
8	8.625	19.00	3.620	10.62	12	1.750	15.50	122
	219.1	482.6	91.90	269.7		44.40	393.7	
10	10.75	23.00	4.250	12.75	12	2.000	19.00	210
	273.0	584.2	107.9	323.9		50.80	482.6	
12	12.75	26.50	4.880	15.00	16	2.120	22.50	316
	323.8	673.1	123.9	381.0		53.8	571.5	
14	14.00	29.50	5.250	16.25	16	2.380	25.00	420
	355.6	749.3	133.3	412.8		60.45	635.0	
16	16.00	32.50	5.750	18.50	16	2.620	27.75	558
	406.4	825.5	146.0	469.9		66.55	704.8	
18	18.00	36.00	6.380	21.00	16	2.880	30.50	760
	457.2	914.4	162.0	533.4		73.15	774.7	
20	20.00	38.75	7.000	23.00	16	3.120	32.75	965
	508.0	984.2	177.8	584.2		79.25	831.8	
24	24.00	46.00	8.000	27.25	16	3.620	39.00	1558
	609.6	1168.4	203.2	692.2		91.90	990.6	



Notes

- Weights are based on manufacturer's data and are approximate.
- For ring joint facings see page 8-6.
- For tolerances see page 8-4.

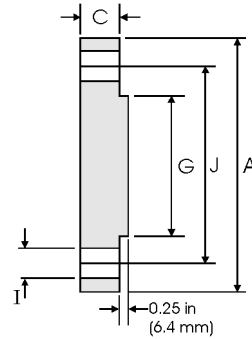
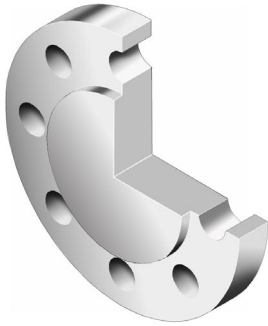
Blind Flanges - ANSI B16.5



Class 2500 lb

Pipe		Flange Data			Raised Face	Drilling Data			Weight
Nominal Pipe Size		A	C	G	H	I	J		
	Outside Diameter	Overall Diameter	Flange Thickness min	Face Diameter	Number of Holes	Bolt Hole Diameter	Diameter of Circle of Holes	kg/piece	
	in mm	in mm	in mm	in mm		in mm	in mm		
1/2	0.840	5.250	1.190	1.380	4	0.880	3.500	2.99	
	21.30	133.4	30.20	35.10		22.40	88.90		
3/4	1.050	5.500	1.250	1.690	4	0.880	3.750	3.50	
	26.70	139.7	31.70	42.90		22.40	95.30		
1	1.315	6.250	1.380	2.000	4	1.000	4.250	4.96	
	33.40	158.8	35.10	50.80		25.40	108.0		
1 1/4	1.660	7.250	1.500	2.500	4	1.120	5.120	7.35	
	42.20	184.2	38.10	63.50		28.40	130.0		
1 1/2	1.900	8.000	1.750	2.880	4	1.250	5.750	10.4	
	48.30	203.2	44.50	73.15		31.75	146.1		
2	2.375	9.250	2.000	3.620	8	1.120	6.750	15.6	
	60.30	235.0	50.80	91.90		28.40	171.5		
2 1/2	2.875	10.50	2.250	4.120	8	1.250	7.750	22.6	
	73.00	266.7	57.15	104.6		31.75	196.9		
3	3.500	12.00	2.620	5.000	8	1.380	9.000	34.8	
	88.90	304.8	66.55	127.0		35.10	228.6		
4	4.500	14.00	3.000	6.190	8	1.620	10.75	53.9	
	114.3	355.6	76.20	157.2		41.10	273.1		
5	5.563	16.50	3.620	7.310	8	1.888	12.75	90.8	
	141.3	419.1	91.90	185.7		47.88	323.9		
6	6.625	19.00	4.250	8.500	8	2.120	14.50	141	
	168.3	482.6	108.0	215.9		53.80	368.3		
8	8.625	21.75	5.000	10.62	12	2.120	17.25	214	
	219.1	552.5	127.0	269.7		53.80	438.2		
10	10.75	26.50	6.500	12.75	12	2.620	21.25	411	
	273.0	673.1	165.1	323.9		66.55	539.8		
12	12.75	30.00	7.250	15.00	12	2.880	24.38	592	
	323.8	762.0	184.2	381.0		73.15	619.3		

Notes

- Weights are based on manufacturer's data and are approximate.
- For ring joint facings see page 8-6.
- For tolerances see page 8-4.

Socket Welding Flanges - ANSI B16.5

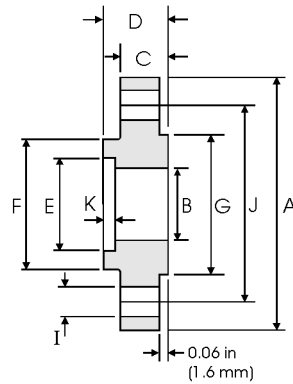
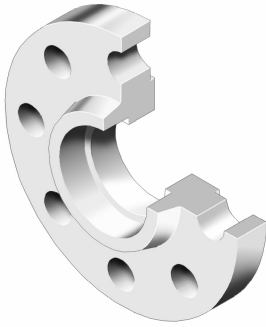

Class 150 lb

Pipe	Flange						Hub	Raised Face	Drilling Data			Weight	
Nominal Pipe Size	A	B	C	D	E	K	F	G	H	I	J	kg/piece	
Outside Diameter	Overall Diameter	Inside Diameter	Flange Thickness min	Overall Length	Socket Diameter	Depth of Socket	Hub Diameter	Face Diameter	No. of Holes	Bolt Hole Diameter	Diameter of Circle of Holes	kg/piece	
in mm	in mm	in mm	in mm	in mm	in mm	in mm	in mm	in mm		in mm	in mm		
1/2	0.840 21.30	3.500 88.90	0.620 15.70	0.440 11.20	0.620 15.70	0.880 22.40	0.380 9.600	1.190 30.20	1.380 35.10	4	0.620 15.70	2.380 60.45	0.42
3/4	1.050 26.70	3.880 98.60	0.820 20.80	0.500 12.70	0.620 15.70	1.090 27.70	0.440 11.10	1.500 38.10	1.690 42.90	4	0.620 15.70	2.750 69.85	0.59
1	1.315 33.40	4.250 108.0	1.050 26.70	0.560 14.20	0.690 17.50	1.360 34.50	0.500 12.70	1.940 49.30	2.000 50.80	4	0.620 15.70	3.120 79.25	0.81
1 1/4	1.660 42.20	4.620 117.3	1.380 35.10	0.620 15.70	0.810 20.60	1.700 43.20	0.560 14.20	2.310 58.70	2.500 63.50	4	0.620 15.70	3.500 88.90	1.07
1 1/2	1.900 48.30	5.000 127.0	1.610 40.90	0.690 17.50	0.880 22.30	1.950 49.50	0.620 15.70	2.560 65.00	2.880 73.15	4	0.620 15.70	3.880 98.60	1.36
2	2.375 60.30	6.000 152.4	2.070 52.60	0.750 19.10	1.000 25.40	2.440 62.00	0.690 17.50	3.060 77.70	3.620 91.90	4	0.750 19.10	4.750 120.7	2.10
2 1/2	2.875 73.00	7.000 177.8	2.470 62.70	0.880 22.40	1.120 28.40	2.940 74.70	0.750 19.00	3.560 90.40	4.120 104.6	4	0.750 19.10	5.500 139.7	3.33
3	3.500 88.90	7.500 190.5	3.070 78.00	0.940 23.90	1.190 30.20	3.570 90.70	0.810 20.60	4.250 108.0	5.000 127.0	4	0.750 19.10	6.000 152.4	3.90

Class 300 lb

Pipe	Flange						Hub	Raised Face	Drilling Data			Weight	
Nominal Pipe Size	A	B	C	D	E	K	F	G	H	I	J	kg/piece	
Outside Diameter	Overall Diameter	Inside Diameter	Flange Thickness min	Overall Length	Socket Diameter	Depth of Socket	Hub Diameter	Face Diameter	No. of Holes	Bolt Hole Diameter	Diameter of Circle of Holes	kg/piece	
in mm	in mm	in mm	in mm	in mm	in mm	in mm	in mm	in mm		in mm	in mm		
1/2	0.840 21.30	3.750 95.20	0.620 15.70	0.560 14.20	0.880 22.30	0.880 22.40	0.380 9.600	1.500 38.10	1.380 35.10	4	0.620 15.70	2.620 66.55	0.66
3/4	1.050 26.70	4.620 117.3	0.820 20.80	0.620 15.70	1.000 25.40	1.090 27.70	0.440 11.10	1.880 47.70	1.690 42.90	4	0.750 19.10	3.250 82.50	1.15
1	1.315 33.40	4.880 123.9	1.050 26.70	0.690 17.50	1.060 26.90	1.360 34.50	0.500 12.70	2.120 53.80	2.000 50.80	4	0.750 19.10	3.500 88.90	1.40
1 1/4	1.660 42.20	5.250 133.3	1.380 35.10	0.750 19.00	1.060 26.90	1.700 43.20	0.560 14.20	2.500 63.50	2.500 63.50	4	0.750 19.10	3.880 98.60	1.75
1 1/2	1.900 48.30	6.120 155.4	1.610 40.90	0.810 20.60	1.190 30.20	1.950 49.50	0.620 15.70	2.750 69.85	2.880 73.15	4	0.880 22.30	4.500 114.3	2.55
2	2.375 60.30	6.500 165.1	2.070 52.60	0.880 22.30	1.310 33.20	2.440 62.00	0.690 17.50	3.310 84.00	3.620 91.90	8	0.750 19.10	5.000 127.0	2.93
2 1/2	2.875 73.00	7.500 190.5	2.470 62.70	1.000 25.40	1.500 38.10	2.940 74.70	0.750 19.00	3.940 100.0	4.120 104.6	8	0.880 22.30	5.880 149.3	4.40
3	3.500 88.90	8.250 209.5	3.070 78.00	1.120 28.40	1.690 42.90	3.570 90.70	0.810 20.60	4.620 117.3	5.000 127.0	8	0.880 22.30	6.620 168.1	5.92

Notes

- Dimension B corresponds to the pipe inside diameter. Values quoted assume 40S/Standard wall thickness.
- Weights are based on manufacturer's data and are approximate.
- For ring joint facings see page 8-6. For tolerances see page 8-4.

Socket Welding Flanges - ANSI B16.5

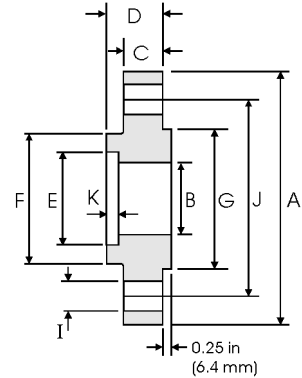
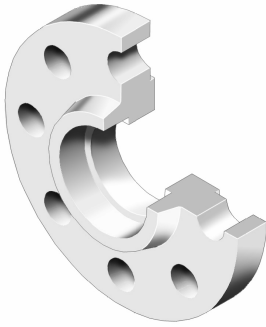

Class 600 lb

Nominal Pipe Size	Pipe	Flange						Hub	Raised Face	Drilling Data			Weight
		A	B	C	D	E	K	F	G	H	I	J	
	Outside Diameter	Overall Diameter	Inside Diameter	Flange Thickness min	Overall Length	Socket Diameter	Depth of Socket	Hub Diameter	Face Diameter	No. of Holes	Bolt Hole Diameter	Diameter of Circle of Holes	kg/ piece
	in mm	in mm	in mm	in mm	in mm	in mm	in mm	in mm	in mm		in mm	in mm	
1/2	0.840 21.30	3.750 95.20	To be specified by the Purchaser	0.560 14.20	0.880 22.30	0.880 22.40	0.380 9.600	1.500 38.10	1.380 35.10	4	0.620 15.70	2.620 66.55	0.76
	3/4	1.050 26.70		4.620 117.3	0.620 15.70	1.000 25.40	1.090 27.70	0.440 11.10	1.880 47.70		1.690 42.90	0.750 19.10	
1	1.315 33.40	4.880 123.9		0.690 17.50	1.060 26.90	1.360 34.50	0.500 12.70	2.120 53.80	2.000 50.80	4	0.750 19.10	3.500 88.90	1.55
	1 1/4	1.660 42.20		5.250 133.3	0.810 20.60	1.120 28.40	1.700 43.20	0.560 14.20	2.500 63.50		2.500 63.50	0.750 19.10	
1 1/2	1.900 48.30	6.120 155.4		0.880 22.30	1.250 31.75	1.950 49.50	0.620 15.70	2.750 69.85	2.880 73.15	4	0.880 22.30	4.500 114.3	3.00
	2	2.375 60.30		6.500 165.1	1.000 25.40	1.440 36.60	2.440 62.00	0.690 17.50	3.310 84.00		3.620 91.90	8	
2 1/2	2.875 73.00	7.500 190.5		1.120 28.40	1.620 41.10	2.940 74.70	0.750 19.00	3.940 100.0	4.120 104.6	8	0.880 22.30	5.880 149.3	5.35
	3	3.500 88.90		8.250 209.5	1.250 31.75	1.810 46.00	3.570 90.70	0.810 20.60	4.620 117.3		5.000 127.0	8	

Class 1500 lb

Nominal Pipe Size	Pipe	Flange						Hub	Raised Face	Drilling Data			Weight
		A	B	C	D	E	K	F	G	H	I	J	
	Outside Diameter	Overall Diameter	Inside Diameter	Flange Thickness min	Overall Length	Socket Diameter	Depth of Socket	Hub Diameter	Face Diameter	No. of Holes	Bolt Hole Diameter	Diameter of Circle of Holes	kg/ piece
	in mm	in mm	in mm	in mm	in mm	in mm	in mm	in mm	in mm		in mm	in mm	
1/2	0.840 21.30	4.750 120.6	To be specified by the Purchaser	0.880 22.30	1.250 31.70	0.880 22.40	0.380 9.600	1.500 38.10	1.380 35.10	4	0.880 22.30	3.250 82.50	1.80
	3/4	1.050 26.70		5.120 130.0	1.000 25.40	1.380 35.00	1.090 27.70	0.440 11.10	1.750 44.40		1.690 42.90	4	
1	1.315 33.40	5.880 149.3		1.120 28.40	1.620 41.10	1.360 34.50	0.500 12.70	2.060 52.30	2.000 50.80	4	1.000 25.40	4.000 101.6	3.55
	1 1/4	1.660 42.20		6.250 158.7	1.120 28.40	1.620 41.10	1.700 43.20	0.560 14.20	2.500 63.50		2.500 63.50	4	
1 1/2	1.900 48.30	7.000 177.8		1.250 31.75	1.750 44.50	1.950 49.50	0.620 15.70	2.750 69.85	2.880 73.15	4	1.120 28.40	4.880 123.9	5.45
	2	2.375 60.30		8.500 215.9	1.500 38.10	2.250 57.15	2.440 62.00	0.690 17.50	4.120 104.6		3.620 91.90	8	
2 1/2	2.875 73.00	9.620 244.3		1.620 41.10	2.500 63.50	2.940 74.70	0.750 19.00	4.880 123.9	4.120 104.6	8	1.120 28.40	7.500 190.5	13.9

Notes

- Class 400 socket weld flanges may be provided in NPS 1/2 to 2 1/2 using Class 600 dimensions
- Dimension B corresponds to the pipe inside diameter. Values quoted assume 40S/Standard wall thickness.
- Weights are based on manufacturer's data and are approximate.
- For ring joint facings see page 8-6. For tolerances see page 8-4.

Lap Joint Flanges - ANSI B16.5

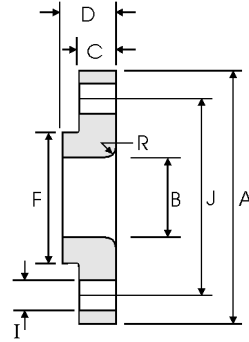
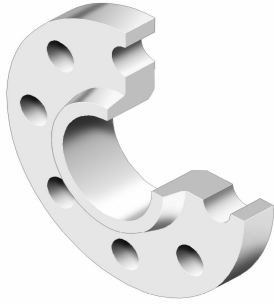

Class 150 lb

Nominal Pipe Size	Pipe	Flange Data				Lap	Hub	Drilling Data			Weight
		A	B	C	D	R	F	H	I	J	
	Outside Diameter	Overall Diameter	Inside Diameter	Flange Thickness min	Overall Length	Lap Radius	Hub Diameter	Number of Holes	Bolt Hole Diameter	Diameter of Circle of Holes	kg/ piece
	in mm	in mm	in mm	in mm	in mm	in mm	in mm		in mm	in mm	
1/2	0.840	3.500	0.900	0.440	0.620	0.120	1.190	4	0.620	2.380	0.38
	21.30	88.90	22.90	11.20	15.70	3.000	30.20		15.70	60.45	
3/4	1.050	3.880	1.110	0.500	0.620	0.120	1.500	4	0.620	2.750	0.55
	26.70	98.60	28.20	12.70	15.70	3.000	38.10		15.70	69.85	
1	1.315	4.250	1.380	0.560	0.690	0.120	1.940	4	0.620	3.120	0.76
	33.40	108.0	35.10	14.20	17.50	3.000	49.30		15.70	79.25	
1 1/4	1.660	4.620	1.720	0.620	0.810	0.190	2.310	4	0.620	3.500	1.01
	42.20	117.3	43.70	15.70	20.60	4.800	58.70		15.70	88.90	
1 1/2	1.900	5.000	1.970	0.690	0.880	0.250	2.560	4	0.620	3.880	1.30
	48.30	127.0	50.00	17.50	22.40	6.400	65.00		15.70	98.60	
2	2.375	6.000	2.460	0.750	1.000	0.310	3.060	4	0.750	4.750	2.03
	60.30	152.4	62.50	19.10	25.40	7.900	77.70		19.10	120.7	
2 1/2	2.875	7.000	2.970	0.880	1.120	0.310	3.560	4	0.750	5.500	3.25
	73.00	177.8	75.40	22.40	28.40	7.900	90.40		19.10	139.7	
3	3.500	7.500	3.600	0.940	1.190	0.380	4.250	4	0.750	6.000	3.81
	88.90	190.5	91.40	23.90	30.20	9.700	108.0		19.10	152.4	
3 1/2	4.000	8.500	4.100	0.940	1.250	0.380	4.810	8	0.750	7.000	4.76
	101.6	215.9	104.1	23.90	31.75	9.700	122.2		19.10	177.8	
4	4.500	9.000	4.600	0.940	1.310	0.440	5.310	8	0.750	7.500	5.25
	114.3	228.6	116.8	23.90	33.30	11.20	134.9		19.10	190.5	
5	5.563	10.00	5.690	0.940	1.440	0.440	6.440	8	0.880	8.500	6.02
	141.3	254.0	114.5	23.90	36.60	11.20	163.6		22.40	215.9	
6	6.625	11.00	6.750	1.000	1.560	0.500	7.560	8	0.880	9.500	7.40
	168.3	279.4	171.5	25.40	39.60	12.70	192.0		22.40	241.3	
8	8.625	13.50	8.750	1.120	1.750	0.500	9.690	8	0.880	11.75	12.1
	219.1	342.9	222.3	28.40	44.50	12.70	246.1		22.40	298.5	
10	10.75	16.00	10.92	1.190	1.940	0.500	12.00	12	1.000	14.25	16.4
	273.0	406.4	277.4	30.20	49.30	12.70	304.8		25.40	362.0	
12	12.75	19.00	12.92	1.250	2.190	0.500	14.38	12	1.000	17.00	26.1
	323.8	482.6	328.2	31.75	55.60	12.70	365.3		25.40	431.8	
14	14.00	21.00	14.18	1.380	3.120	0.500	15.75	12	1.120	18.75	34.5
	355.6	533.4	360.2	35.10	79.25	12.70	400.1		28.40	476.3	
16	16.00	23.50	16.19	1.440	3.440	0.500	18.00	16	1.120	21.25	44.6
	406.4	596.9	411.2	36.60	87.40	12.70	457.2		28.40	539.8	
18	18.00	25.00	18.20	1.560	3.810	0.500	19.88	16	1.250	22.75	48.7
	457.2	635.0	462.3	39.60	96.80	12.70	505.0		31.75	577.9	
20	20.00	27.50	20.25	1.690	4.060	0.500	22.00	20	1.250	25.00	61.6
	508.0	698.5	514.4	42.90	103.1	12.70	558.8		31.75	635.0	
24	24.00	32.00	24.25	1.880	4.380	0.500	26.12	20	1.380	29.50	86.6
	609.6	812.8	616.0	47.80	111.3	12.70	663.4		35.10	749.3	

Notes

- Weights are based on manufacturer's data and are approximate.
- For tolerances see page 8-4.

Lap Joint Flanges - ANSI B16.5

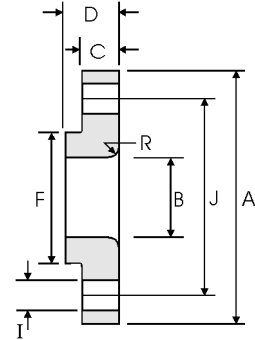

Class 300 lb

Nominal Pipe Size	Pipe	Flange Data				Lap	Hub	Drilling Data			Weight
		A	B	C	D	R	F	H	I	J	
	Outside Diameter	Overall Diameter	Inside Diameter	Flange Thickness min	Overall Length	Lap Radius	Hub Diameter	Number of Holes	Bolt Hole Diameter	Diameter of Circle of Holes	kg/ piece
	in mm	in mm	in mm	in mm	in mm	in mm	in mm		in mm	in mm	
1/2	0.840	3.750	0.900	0.560	0.880	0.120	1.500	4	0.620	2.620	0.62
	21.30	95.20	22.90	14.20	22.30	3.000	38.10		15.70	66.55	
3/4	1.050	4.620	1.110	0.620	1.000	0.120	1.880	4	0.750	3.250	1.10
	26.70	117.3	28.20	15.70	25.40	3.000	47.70		19.00	82.50	
1	1.315	4.880	1.380	0.690	1.060	0.120	2.120	4	0.750	3.500	1.33
	33.40	123.9	35.10	17.50	26.90	3.000	53.80		19.0	88.90	
1 1/4	1.660	5.250	1.720	0.750	1.060	0.190	2.500	4	0.750	3.880	1.65
	42.20	133.3	43.70	19.00	26.90	4.800	63.50		19.00	98.50	
1 1/2	1.900	6.120	1.970	0.810	1.190	0.250	2.750	4	0.880	4.500	2.44
	48.30	155.4	50.00	20.60	30.20	6.400	69.85		22.30	114.3	
2	2.375	6.500	2.460	0.880	1.310	0.310	3.310	8	0.750	5.000	2.83
	60.30	165.1	62.50	22.30	33.20	7.900	84.00		19.10	127.0	
2 1/2	2.875	7.500	2.970	1.000	1.500	0.310	3.940	8	0.880	5.880	4.25
	73.00	190.5	75.40	25.40	38.10	7.900	100.0		22.30	149.3	
3	3.500	8.250	3.600	1.120	1.690	0.380	4.620	8	0.880	6.620	5.78
	88.90	209.5	91.40	28.40	42.90	9.700	117.3		22.30	168.1	
3 1/2	4.000	9.000	4.100	1.190	1.750	0.380	5.250	8	0.880	7.250	7.27
	101.6	228.6	104.1	30.20	44.40	9.700	133.3		22.30	184.1	
4	4.500	10.00	4.600	1.250	1.880	0.440	5.750	8	0.880	7.880	9.55
	114.3	254.0	116.8	31.70	47.70	11.20	146.0		22.30	200.1	
5	5.563	11.00	5.690	1.380	2.000	0.440	7.000	8	0.880	9.250	12.2
	141.3	279.4	114.5	35.00	50.80	11.20	177.8		22.30	234.9	
6	6.625	12.50	6.750	1.440	2.060	0.500	8.120	12	0.880	10.62	15.5
	168.3	317.5	171.5	36.50	52.30	12.70	206.2		22.30	269.7	
8	8.625	15.00	8.750	1.620	2.440	0.500	10.25	12	1.000	13.00	24.1
	219.1	381.0	222.3	41.10	61.90	12.70	260.3		25.40	330.2	
10	10.75	17.50	10.92	1.880	3.750	0.500	12.62	16	1.120	15.25	34.4
	273.0	444.5	277.4	47.70	95.20	12.70	320.5		28.40	387.3	
12	12.75	20.50	12.92	2.000	4.000	0.500	14.75	16	1.250	17.75	50.4
	323.8	520.7	328.2	50.80	101.6	12.70	374.6		31.70	450.8	
14	14.00	23.00	14.18	2.120	4.380	0.500	16.75	20	1.250	20.25	70.9
	355.6	584.2	360.2	53.80	111.2	12.70	425.4		31.70	514.3	
16	16.00	25.50	16.19	2.250	4.750	0.500	19.00	20	1.380	22.50	89.5
	406.4	647.7	411.2	57.15	120.6	12.70	482.6		35.00	571.5	
18	18.00	28.00	18.20	2.380	5.120	0.500	21.00	24	1.380	24.75	111
	457.2	711.2	462.3	60.45	130.0	12.70	533.4		35.00	628.6	
20	20.00	30.50	20.25	2.500	5.500	0.500	23.12	24	1.380	27.00	137
	508.0	774.7	514.4	63.50	139.7	12.70	587.2		35.0	685.8	
24	24.00	36.00	24.25	2.750	6.000	0.500	27.62	24	1.620	32.00	204
	609.6	914.4	616.0	69.8	152.4	12.70	701.5		41.10	812.8	

Notes

- Weights are based on manufacturer's data and are approximate.
- For tolerances see page 8-4.

Lap Joint Flanges - ANSI B16.5

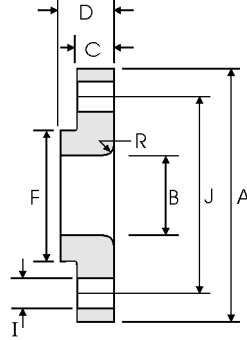

Class 400 lb

Nominal Pipe Size	Pipe	Flange Data				Lap	Hub	Drilling Data			Weight
		A	B	C	D	R	F	H	I	J	
	Outside Diameter	Overall Diameter	Inside Diameter	Flange Thickness min	Overall Length	Lap Radius	Hub Diameter	Number of Holes	Bolt Hole Diameter	Diameter of Circle of Holes	kg/ piece
	in mm	in mm	in mm	in mm	in mm	in mm	in mm		in mm	in mm	
1/2	0.840	3.750	0.900	0.560	0.880	0.120	1.500	4	0.620	2.620	0.72
	21.30	95.30	22.90	14.20	22.40	3.000	38.10		15.70	66.55	
3/4	1.050	4.620	1.110	0.620	1.000	0.120	1.880	4	0.750	3.250	1.25
	26.70	117.3	28.20	15.70	25.40	3.000	47.80		19.10	82.60	
1	1.315	4.880	1.380	0.690	1.060	0.120	2.120	4	0.750	3.500	1.50
	33.40	124.0	35.10	17.50	26.90	3.000	53.80		19.10	88.90	
1 1/4	1.660	5.250	1.720	0.810	1.120	0.190	2.500	4	0.750	3.880	2.00
	42.20	133.4	43.70	20.60	28.40	4.800	63.50		19.10	98.60	
1 1/2	1.900	6.120	1.970	0.880	1.250	0.250	2.750	4	0.880	4.500	2.92
	48.30	155.4	50.00	22.40	31.75	6.400	69.85		22.40	114.3	
2	2.375	6.500	2.460	1.000	1.440	0.310	3.310	8	0.750	5.000	3.55
	60.30	165.1	62.50	25.40	36.60	7.900	84.10		19.10	127.0	
2 1/2	2.875	7.500	2.970	1.120	1.620	0.310	3.940	8	0.880	5.880	5.23
	73.00	190.5	75.40	28.40	41.10	7.900	100.1		22.40	149.4	
3	3.500	8.250	3.600	1.125	1.810	0.380	4.620	8	0.880	6.620	6.95
	88.90	209.6	91.40	31.75	46.00	9.700	117.3		22.40	168.1	
3 1/2	4.000	9.000	4.100	1.380	1.940	0.380	5.250	8	1.000	7.250	8.78
	101.6	228.6	104.1	35.10	49.30	9.700	133.4		25.40	184.2	
4	4.500	10.00	4.600	1.380	2.000	0.440	5.750	8	1.000	7.880	10.9
	114.3	254.0	116.8	35.10	50.80	11.20	146.1		25.40	200.2	
5	5.563	11.00	5.690	1.500	2.120	0.440	7.000	8	1.000	9.250	13.7
	141.3	279.4	114.5	38.10	53.80	11.20	177.8		25.40	235.0	
6	6.625	12.50	6.750	1.620	2.250	0.500	8.120	12	1.000	10.62	18.0
	168.3	317.5	171.5	41.10	57.15	12.70	206.2		25.40	269.7	
8	8.625	15.00	8.750	1.880	2.690	0.500	10.25	12	1.120	13.00	28.3
	219.1	381.0	222.3	47.80	68.30	12.70	260.4		28.40	330.2	
10	10.75	17.50	10.92	2.120	4.000	0.500	12.62	16	1.250	15.25	38.8
	273.0	444.5	277.4	53.80	101.6	12.70	320.5		31.75	387.4	
12	12.75	20.50	12.92	2.250	4.250	0.500	14.75	16	1.380	17.75	56.6
	323.8	520.7	328.2	57.15	108.0	12.70	374.7		35.10	450.9	
14	14.00	23.00	14.18	2.380	4.620	0.500	16.75	20	1.380	20.25	78.6
	355.6	584.2	360.2	60.45	117.3	12.70	425.5		35.10	514.4	
16	16.00	25.50	16.19	2.500	5.000	0.500	19.00	20	1.500	22.50	100
	406.4	647.7	411.2	63.50	127.0	12.70	482.6		38.10	571.5	
18	18.00	28.00	18.20	2.620	5.380	0.500	21.00	24	1.500	24.75	122
	457.2	711.2	462.3	66.55	136.7	12.70	533.4		38.10	628.7	
20	20.00	30.50	20.25	2.750	5.750	0.500	23.12	24	1.620	27.00	145
	508.0	774.7	514.4	69.85	146.1	12.70	587.2		41.10	685.8	
24	24.00	36.00	24.25	3.000	6.250	0.500	27.62	24	1.880	32.00	217
	609.6	914.4	616.0	76.20	158.8	12.70	701.5		47.80	812.8	

Notes

- Weights are based on manufacturer's data and are approximate.
- For tolerances see page 8-4.

Lap Joint Flanges - ANSI B16.5

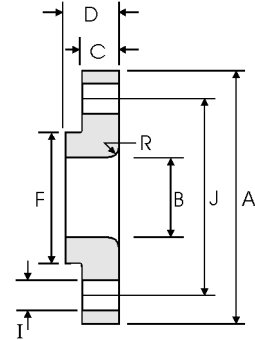

Class 600 lb

Nominal Pipe Size	Pipe	Flange Data				Lap	Hub	Drilling Data			Weight
		A	B	C	D	R	F	H	I	J	
	Outside Diameter	Overall Diameter	Inside Diameter	Flange Thickness min	Overall Length	Lap Radius	Hub Diameter	Number of Holes	Bolt Hole Diameter	Diameter of Circle of Holes	kg/ piece
	in mm	in mm	in mm	in mm	in mm	in mm	in mm		in mm	in mm	
1/2	0.840	3.750	0.900	0.560	0.880	0.120	1.500	4	0.620	2.620	0.72
	21.30	95.30	22.90	14.20	22.40	3.000	38.10		15.70	66.55	
3/4	1.050	4.620	1.110	0.620	1.000	0.120	1.880	4	0.750	3.250	1.25
	26.70	117.3	28.20	15.70	25.40	3.000	47.80		19.10	82.60	
1	1.315	4.880	1.380	0.690	1.060	0.120	2.120	4	0.750	3.500	1.50
	33.40	124.0	35.10	17.50	26.90	3.000	53.80		19.10	88.90	
1 1/4	1.660	5.250	1.720	0.810	1.120	0.190	2.500	4	0.750	3.880	2.00
	42.20	133.4	43.70	20.60	28.40	4.800	63.50		19.10	98.60	
1 1/2	1.900	6.120	1.970	0.880	1.250	0.250	2.750	4	0.880	4.500	2.92
	48.30	155.4	50.00	22.40	31.75	6.400	69.85		22.40	114.3	
2	2.375	6.500	2.460	1.000	1.440	0.310	3.310	8	0.750	5.000	3.55
	60.30	165.1	62.50	25.40	36.60	7.900	84.10		19.10	127.0	
2 1/2	2.875	7.500	2.970	1.120	1.620	0.310	3.940	8	0.880	5.880	5.23
	73.00	190.5	75.40	28.40	41.10	7.900	100.1		22.40	149.4	
3	3.500	8.250	3.600	1.125	1.810	0.380	4.620	8	0.880	6.620	6.95
	88.90	209.6	91.40	31.75	46.00	9.700	117.3		22.40	168.1	
3 1/2	4.000	9.000	4.100	1.380	1.940	0.380	5.250	8	1.000	7.250	8.78
	101.6	228.6	104.1	35.10	49.30	9.700	133.4		25.40	184.2	
4	4.500	10.75	4.600	1.500	2.120	0.440	6.000	8	1.000	8.500	14.4
	114.3	273.1	116.8	38.10	53.80	11.20	152.4		25.40	215.9	
5	5.563	13.00	5.690	1.750	2.380	0.440	7.440	8	1.120	10.50	24.3
	141.3	330.2	114.5	44.50	60.45	11.20	189.0		28.40	266.7	
6	6.625	14.00	6.750	1.880	2.620	0.500	8.750	12	1.120	11.50	28.5
	168.3	355.6	171.5	47.80	66.55	12.70	222.3		28.40	292.1	
8	8.625	16.50	8.750	2.190	3.000	0.500	10.75	12	1.250	13.75	43.1
	219.1	419.1	222.3	55.60	76.20	12.70	273.1		31.75	349.3	
10	10.75	20.00	10.92	2.500	4.380	0.500	13.50	16	1.380	17.00	70.5
	273.0	508.0	277.4	63.50	111.3	12.70	342.9		35.10	431.8	
12	12.75	22.00	12.92	2.620	4.620	0.500	15.75	20	1.380	19.25	86.1
	323.8	558.8	328.2	66.55	117.3	12.70	400.1		35.10	489.0	
14	14.00	23.75	14.18	2.750	5.000	0.500	17.00	20	1.500	20.75	100
	355.6	603.3	360.2	69.85	127.0	12.70	431.8		38.10	527.1	
16	16.00	27.00	16.19	3.000	5.500	0.500	19.50	20	1.620	23.75	145
	406.4	685.8	411.2	76.20	139.7	12.70	495.3		41.10	603.3	
18	18.00	29.25	18.20	3.250	6.000	0.500	21.50	20	1.750	25.75	177
	457.2	743.0	462.3	82.60	152.4	12.70	546.1		44.50	654.1	
20	20.00	32.00	20.25	3.500	6.500	0.500	24.00	24	1.750	28.50	225
	508.0	812.8	514.4	88.90	165.1	12.70	609.6		44.50	723.9	
24	24.00	37.00	24.25	4.000	7.250	0.500	28.25	24	2.000	33.00	318
	609.6	939.8	616.0	101.6	184.2	12.70	717.6		50.80	838.2	

Notes

- Weights are based on manufacturer's data and are approximate.
- For tolerances see page 8-4.

Lap Joint Flanges - ANSI B16.5

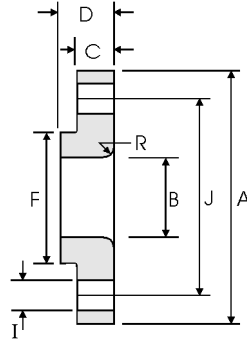

Class 900 lb

Nominal Pipe Size	Pipe	Flange Data				Lap	Hub	Drilling Data			Weight
		A	B	C	D	R	F	H	I	J	
	Outside Diameter	Overall Diameter	Inside Diameter	Flange Thickness min	Overall Length	Lap Radius	Hub Diameter	Number of Holes	Bolt Hole Diameter	Diameter of Circle of Holes	kg/ piece
	in mm	in mm	in mm	in mm	in mm	in mm	in mm		in mm	in mm	
1/2	0.840	4.750	0.900	0.880	1.250	0.120	1.500	4	0.880	3.250	1.71
	21.30	120.6	22.90	22.30	31.70	3.000	38.10		22.30	82.50	
3/4	1.050	5.120	1.110	1.000	1.380	0.120	1.750	4	0.880	3.500	2.30
	26.70	130.0	28.20	25.40	35.00	3.000	44.40		22.30	88.90	
1	1.315	5.880	1.380	1.120	1.620	0.120	2.060	4	1.000	4.000	3.40
	33.40	149.3	35.10	28.40	41.10	3.000	52.30		25.40	101.6	
1 1/4	1.660	6.250	1.720	1.120	1.620	0.190	2.500	4	1.000	4.380	3.85
	42.20	158.7	43.70	28.40	41.10	4.800	63.50		25.40	111.2	
1 1/2	1.900	7.000	1.970	1.250	1.750	0.250	2.750	4	1.120	4.880	5.28
	48.30	177.8	50.00	31.70	44.40	6.400	69.85		28.40	123.9	
2	2.375	8.500	2.460	1.500	2.250	0.310	4.120	8	1.000	6.500	9.78
	60.30	215.9	62.50	38.10	57.15	7.900	104.6		25.40	165.1	
2 1/2	2.875	9.620	2.970	1.620	2.500	0.310	4.880	8	1.120	7.500	13.6
	73.00	244.3	75.40	41.10	63.50	7.900	123.9		28.40	190.5	
3	3.500	9.500	3.600	1.500	2.120	0.380	5.000	8	1.000	7.500	11.3
	88.90	241.3	91.40	38.10	53.80	9.700	127.0		25.40	190.5	
4	4.500	11.50	4.600	1.750	2.750	0.440	6.250	8	1.250	9.250	19.2
	114.3	292.1	116.8	44.40	69.85	11.20	158.7		31.70	234.9	
5	5.563	13.75	5.690	2.000	3.120	0.440	7.500	8	1.380	11.00	31.20
	141.3	349.2	114.5	50.80	79.25	11.20	190.5		35.00	279.4	
6	6.625	15.00	6.750	2.190	3.380	0.500	9.250	12	1.250	12.50	40.50
	168.3	381.0	171.5	55.60	85.80	12.70	234.9		31.70	317.5	
8	8.625	18.50	8.750	2.500	4.500	0.500	11.75	12	1.500	15.50	71.5
	219.1	469.9	222.3	63.50	114.3	12.70	298.4		38.10	393.7	
10	10.75	21.50	10.92	2.750	5.000	0.500	14.50	16	1.500	18.50	104
	273.0	546.1	277.4	69.85	127.0	12.70	368.3		38.10	469.9	
12	12.75	24.00	12.92	3.120	5.620	0.500	16.50	20	1.500	21.00	139
	323.8	609.6	328.2	79.25	142.7	12.70	419.1		38.10	533.4	
14	14.00	25.25	14.18	3.380	6.120	0.500	17.75	20	1.620	22.00	161
	355.6	641.3	360.2	85.80	155.4	12.70	450.8		41.10	558.8	
16	16.00	27.75	16.19	3.500	6.500	0.500	20.00	20	1.750	24.25	194
	406.4	704.8	411.2	88.90	165.1	12.70	508.0		44.40	615.9	
18	18.00	31.00	18.20	4.000	7.500	0.500	22.25	20	2.000	27.00	267
	457.2	787.4	462.3	101.6	190.5	12.70	565.1		50.80	685.8	
20	20.00	33.75	20.25	4.250	8.250	0.500	24.50	20	2.120	29.50	334
	508.0	857.2	514.4	107.9	209.5	12.70	622.3		53.80	749.3	
24	24.00	41.00	24.25	50.50	10.50	0.500	29.50	20	2.620	35.50	618
	609.6	1041.4	616.0	139.7	266.7	12.70	749.3		66.55	901.7	

Notes

- Weights are based on manufacturer's data and are approximate.
- For tolerances see page 8-4.

Lap Joint Flanges - ANSI B16.5

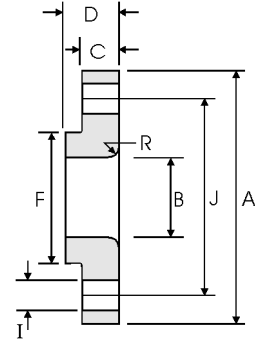

Class 1500 lb

Nominal Pipe Size	Pipe	Flange Data				Lap	Hub	Drilling Data			Weight
		A	B	C	D	R	F	H	I	J	
	Outside Diameter	Overall Diameter	Inside Diameter	Flange Thickness min	Overall Length	Lap Radius	Hub Diameter	Number of Holes	Bolt Hole Diameter	Diameter of Circle of Holes	kg/ piece
	in mm	in mm	in mm	in mm	in mm	in mm	in mm		in mm	in mm	
1/2	0.840	4.750	0.900	0.880	1.250	0.120	1.500	4	0.880	3.250	1.71
	21.30	120.6	22.90	22.30	31.70	3.000	38.10		22.30	82.50	
3/4	1.050	5.120	1.110	1.000	1.380	0.120	1.750	4	0.880	3.500	2.30
	26.70	130.0	28.20	25.40	35.00	3.000	44.40		22.30	88.90	
1	1.315	5.880	1.380	1.120	1.620	0.120	2.060	4	1.000	4.000	3.40
	33.40	149.3	35.10	28.40	41.10	3.000	52.30		25.40	101.6	
1 1/4	1.660	6.250	1.720	1.120	1.620	0.190	2.500	4	1.000	4.380	3.85
	42.20	158.7	43.70	28.40	41.10	4.800	63.50		25.40	111.2	
1 1/2	1.900	7.000	1.970	1.250	1.750	0.250	2.750	4	1.120	4.880	5.28
	48.30	177.8	50.00	31.70	44.40	6.400	69.85		28.40	123.9	
2	2.375	8.500	2.460	1.500	2.250	0.310	4.120	8	1.000	6.500	9.78
	60.30	215.9	62.50	38.10	57.15	7.900	104.6		25.40	165.1	
2 1/2	2.875	9.620	2.970	1.620	2.500	0.310	4.880	8	1.120	7.500	13.6
	73.00	244.3	75.40	41.10	63.50	7.900	123.9		28.40	190.5	
3	3.500	10.50	3.600	1.880	2.880	0.380	5.250	8	1.250	8.000	17.8
	88.90	266.7	91.40	47.70	73.15	9.700	133.3		31.70	203.2	
4	4.500	12.25	4.600	2.120	3.560	0.440	6.380	8	1.380	9.500	27.5
	114.3	311.1	116.8	53.80	90.40	11.20	162.0		35.00	241.3	
5	5.563	14.75	5.690	2.880	4.120	0.440	7.750	8	1.620	11.50	51.5
	141.3	374.6	114.5	73.15	104.6	11.20	196.8		41.10	292.1	
6	6.625	15.50	6.750	3.250	4.690	0.500	9.000	12	1.500	12.50	62.0
	168.3	399.7	171.5	82.50	119.1	12.70	228.6		38.10	317.5	
8	8.625	19.00	8.750	3.620	5.620	0.500	11.50	12	1.750	15.50	105
	219.1	482.6	222.3	91.90	142.7	12.70	292.1		44.40	393.7	
10	10.75	23.00	10.92	4.250	7.000	0.500	14.50	12	2.000	19.00	179
	273.0	584.2	277.4	107.9	177.8	12.70	368.3		50.80	482.6	
12	12.75	26.50	12.92	4.880	8.620	0.500	17.75	16	2.120	22.50	269
	323.8	673.1	328.2	123.9	218.9	12.70	450.8		53.80	571.5	
14	14.00	29.50	14.18	5.250	9.500	0.500	19.50	16	2.380	25.00	365
	355.6	749.3	360.2	133.3	241.3	12.70	495.3		60.45	635.0	
16	16.00	32.50	16.19	5.750	10.25	0.500	21.75	16	2.620	27.75	459
	406.4	825.5	411.2	146.0	260.3	12.70	552.4		66.55	704.8	
18	18.00	36.00	18.20	6.380	10.88	0.500	23.50	16	2.880	30.50	598
	457.2	914.4	462.3	162.0	276.3	12.70	596.9		73.15	774.7	
20	20.00	38.75	20.25	7.000	11.50	0.500	25.25	16	3.120	32.75	712
	508.0	984.2	514.4	177.8	292.1	12.70	641.3		79.25	831.8	
24	24.00	46.00	24.25	8.000	13.00	0.500	30.00	16	3.620	39.00	1090
	609.6	1168.4	616.0	203.2	330.2	12.70	762.0		91.90	990.6	

Notes

- Weights are based on manufacturer's data and are approximate.
- For tolerances see page 8-4.

Lap Joint Flanges - ANSI B16.5

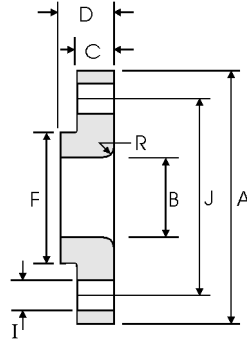

Class 2500 lb

Nominal Pipe Size	Pipe	Flange Data				Lap	Hub	Drilling Data			Weight
		A	B	C	D	R	F	H	I	J	
	Outside Diameter	Overall Diameter	Inside Diameter	Flange Thickness min	Overall Length	Lap Radius	Hub Diameter	Number of Holes	Bolt Hole Diameter	Diameter of Circle of Holes	kg/ piece
	in mm	in mm	in mm	in mm	in mm	in mm	in mm		in mm	in mm	
1/2	0.840	5.255	0.900	1.190	1.560	0.120	1.690	4	0.880	3.500	2.92
	21.30	133.4	22.90	30.20	39.60	3.000	42.90		22.40	88.90	
3/4	1.050	5.500	1.110	1.250	1.690	0.120	2.000	4	0.880	3.750	3.40
	26.70	139.7	28.20	31.75	42.90	3.000	50.80		22.40	95.30	
1	1.315	6.250	1.380	1.380	1.880	0.120	2.250	4	1.000	4.250	4.77
	33.40	158.8	35.10	35.10	47.80	3.000	57.15		25.40	108.0	
1 1/4	1.660	7.250	1.720	1.500	2.060	0.190	2.880	4	1.120	5.120	7.08
	42.20	184.2	43.70	38.10	52.30	4.800	73.15		28.40	130.0	
1 1/2	1.900	8.000	1.970	1.750	2.380	0.250	3.120	4	1.250	5.750	9.93
	48.30	203.2	50.00	44.50	60.45	6.400	79.25		31.75	146.1	
2	2.375	9.250	2.460	2.000	2.750	0.310	3.750	8	1.120	6.750	14.7
	60.30	235.0	62.50	50.80	69.85	7.900	95.30		28.40	171.5	
2 1/2	2.875	10.50	2.970	2.250	3.120	0.310	4.500	8	1.250	7.750	21.3
	73.00	266.7	75.40	57.15	79.25	7.900	114.3		31.75	196.9	
3	3.500	12.00	3.600	2.620	3.620	0.380	5.250	8	1.380	9.000	32.3
	88.90	304.8	91.40	66.55	91.90	9.700	133.4		35.10	228.6	
4	4.500	14.00	4.600	3.000	4.250	0.440	6.500	8	1.620	10.75	52.5
	114.3	355.6	116.8	76.20	108.0	11.20	165.1		41.10	273.1	
5	5.563	16.50	5.690	3.620	5.120	0.440	8.000	8	1.880	12.75	82.6
	141.3	419.1	114.5	91.90	130.0	11.20	203.2		47.80	323.9	
6	6.625	19.00	6.750	4.250	6.000	0.500	9.250	8	2.120	14.50	127
	168.3	482.6	171.5	108.0	152.4	12.70	235.0		53.80	368.3	
8	8.625	21.75	8.750	5.000	7.000	0.500	12.00	12	2.120	17.25	186
	219.1	552.5	222.3	127.0	177.8	12.70	304.8		53.80	438.2	
10	10.75	26.50	10.92	6.500	9.000	0.500	14.75	12	2.620	21.25	352
	273.0	673.1	277.4	165.1	228.6	12.70	374.7		66.55	539.8	
12	12.75	30.00	12.92	7.250	10.00	0.500	17.38	12	2.880	24.38	501
	323.8	762.0	328.2	184.2	254.0	12.70	441.5		73.15	619.3	

Notes

- Weights are based on manufacturer's data and are approximate.
- For tolerances see page 8-4.

Threaded Flanges - ANSI B16.5

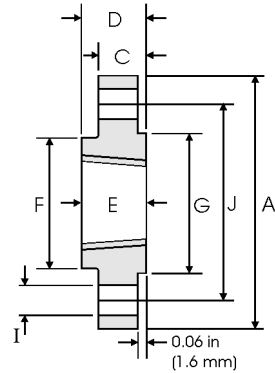

Class 150 lb

Pipe		Flange Data				Hub	Raised Face	Drilling Data			Weight
Nominal Pipe Size		A	C	D	E	F	G	H	I	J	
	Outside Diameter	Overall Diameter	Flange Thickness min	Overall Length	Threaded length min	Hub Diameter	Face Diameter	Number of Holes	Bolt Hole Diameter	Diameter of Circle of Holes	kg/ piece
	in mm	in mm	in mm	in mm	in mm	in mm	in mm		in mm	in mm	
1/2	0.840 21.30	3.500 88.90	0.440 11.20	0.620 15.70	0.620 15.70	1.190 30.20	1.380 35.10	4	0.620 15.70	2.380 60.45	0.39
3/4	1.050 26.70	3.880 98.60	0.500 12.70	0.620 15.70	0.620 15.70	1.500 38.10	1.690 42.90	4	0.620 15.70	2.750 69.85	0.56
1	1.315 33.40	4.250 108.0	0.560 14.20	0.690 17.50	0.690 17.50	1.940 49.30	2.000 50.80	4	0.620 15.70	3.120 79.25	0.78
1 1/4	1.660 42.20	4.620 117.3	0.620 15.70	0.810 20.60	0.810 20.60	2.310 58.70	2.500 63.50	4	0.620 15.70	3.500 88.90	1.03
1 1/2	1.900 48.30	5.000 127.0	0.690 17.50	0.880 22.40	0.880 22.30	2.560 65.00	2.880 73.15	4	0.620 15.70	3.880 98.60	1.32
2	2.375 60.30	6.000 152.4	0.750 19.10	1.000 25.40	1.000 25.40	3.060 77.70	3.620 91.90	4	0.750 19.10	4.750 120.7	2.06
2 1/2	2.875 73.00	7.000 177.8	0.880 22.40	1.120 28.40	1.120 28.40	3.560 90.40	4.120 104.6	4	0.750 19.10	5.500 139.7	3.28
3	3.500 88.90	7.500 190.5	0.940 23.90	1.190 30.20	1.190 30.20	4.250 108.0	5.000 127.0	4	0.750 19.10	6.000 152.4	3.85
3 1/2	4.000 101.6	8.500 215.9	0.940 23.90	1.250 31.75	1.250 31.75	4.810 122.2	5.500 139.7	8	0.750 19.10	7.000 177.8	4.81
4	4.500 114.3	9.000 228.6	0.940 23.90	1.310 33.30	1.310 33.30	5.310 134.9	6.190 157.2	8	0.750 19.10	7.500 190.5	5.30
5	5.563 141.3	10.00 254.0	0.940 23.90	1.440 36.60	1.440 36.60	6.440 163.6	7.310 185.7	8	0.880 22.40	8.500 215.9	6.07
6	6.625 168.3	11.00 279.4	1.000 25.40	1.560 39.60	1.560 39.60	7.560 192.0	8.500 215.9	8	0.880 22.40	9.500 241.3	7.45
8	8.625 219.1	13.50 342.9	1.120 28.40	1.750 44.50	1.750 44.50	9.690 246.1	10.62 269.7	8	0.880 22.40	11.75 298.5	12.1
10	10.75 273.0	16.00 406.4	1.190 30.20	1.940 49.30	1.940 49.30	12.00 304.8	12.75 323.9	12	1.000 25.40	14.25 362.0	16.5
12	12.75 323.8	19.00 482.6	1.250 31.75	2.190 55.60	2.190 55.60	14.38 365.3	15.00 381.0	12	1.000 25.40	17.00 431.8	26.2
14	14.00 355.6	21.00 533.4	1.380 35.10	2.250 57.15	2.250 57.15	15.75 400.1	16.25 412.7	12	1.120 28.40	18.75 476.3	34.6
16	16.00 406.4	23.50 596.9	1.440 36.60	2.500 63.50	2.500 63.50	18.00 457.2	18.50 469.9	16	1.120 28.40	21.25 539.8	44.8
18	18.00 457.2	25.00 635.0	1.560 39.60	2.690 68.30	2.690 68.30	19.88 505.0	21.00 533.4	16	1.250 31.75	22.75 577.9	48.9
20	20.00 508.0	27.50 698.5	1.690 42.90	2.880 73.15	2.880 73.15	22.00 558.8	23.00 584.2	20	1.250 31.75	25.00 635.0	61.9
24	24.00 609.6	32.00 812.8	1.880 47.80	3.250 82.60	3.250 82.60	26.12 663.4	27.25 692.2	20	1.380 35.10	29.50 749.3	86.9

Notes

- The thread conforms to ASME B1.20.1 NTP threads as described in Section 10. (The only exceptions are small male and female plain face threaded flanges which use NPSL recount threads.)
- Class 150 threaded flanges are made without a counterbore. Threads are chamfered to the major diameter (approx.) at an angle of 45° (approx.) at the back of the flange.
- Weights are based on manufacturer's data and are approximate.
- For tolerances see page 8-4.

Threaded Flanges - ANSI B16.5

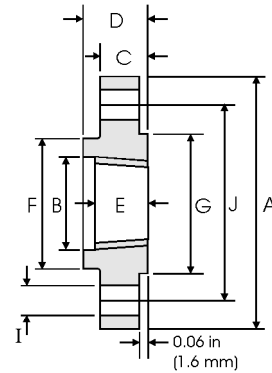
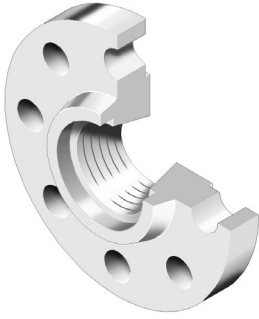

Class 300 lb

Pipe		Flange Data					Hub	Raised Face	Drilling Data			Weight
Nominal Pipe Size		A	B	C	D	E	F	G	H	I	J	
	Outside Diameter	Overall Diameter	Counter-bore min	Flange Thickness min	Overall Length	Threaded length min	Hub Diameter	Face Diameter	Number of Holes	Bolt Hole Diameter	Diameter of Circle of Holes	kg/ piece
	in mm	in mm	in mm	in mm	in mm	in mm	in mm	in mm				
1/2	0.840	3.750	0.930	0.560	0.880	0.620	1.500	1.380	4	0.620	2.620	0.64
	21.30	95.20	23.60	14.20	22.30	15.70	38.10	35.00				
3/4	1.050	4.620	1.140	0.620	1.000	0.620	1.880	1.690	4	0.750	3.250	1.12
	26.70	117.3	29.00	15.70	25.40	15.70	47.70	42.90				
1	1.315	4.880	1.410	0.690	1.060	0.690	2.120	2.000	4	0.750	3.500	1.36
	33.40	123.9	35.80	17.50	26.90	17.50	53.80	50.80				
1 1/4	1.660	5.250	1.750	0.750	1.060	0.810	2.500	2.500	4	0.750	3.880	1.68
	42.20	133.3	44.40	19.00	26.90	20.60	63.50	63.50				
1 1/2	1.900	6.120	1.980	0.810	1.190	0.880	2.750	2.880	4	0.880	4.500	2.49
	48.30	155.4	50.50	20.60	30.20	22.30	69.85	73.15				
2	2.375	6.500	2.500	0.880	1.310	1.120	3.310	3.620	8	0.750	5.000	2.87
	60.30	165.1	63.50	22.30	33.20	28.40	84.00	91.90				
2 1/2	2.875	7.500	3.000	1.000	1.500	1.250	3.940	4.120	8	0.880	5.880	4.32
	73.00	190.5	76.20	25.40	38.10	31.70	100.0	104.6				
3	3.500	8.250	3.630	1.120	1.690	1.250	4.620	5.000	8	0.880	6.620	5.85
	88.90	209.5	92.20	28.40	42.90	31.70	117.3	127.0				
3 1/2	4.000	9.000	4.130	1.190	1.750	1.440	5.250	5.500	8	0.880	7.250	7.34
	101.6	228.6	104.9	30.20	44.40	36.50	133.3	139.7				
4	4.500	10.00	4.630	1.250	1.880	1.440	5.750	6.190	8	0.880	7.880	9.61
	114.3	254.0	117.6	31.70	47.70	36.50	146.0	157.2				
5	5.563	11.00	5.690	1.380	2.000	1.690	7.000	7.310	8	0.880	9.250	12.3
	141.3	279.4	144.5	35.00	50.80	42.90	177.8	185.7				
6	6.625	12.50	6.750	1.440	2.060	1.810	8.120	8.500	12	0.880	10.62	15.6
	168.3	317.5	171.4	36.50	52.30	45.90	206.2	215.9				
8	8.625	15.00	8.750	1.620	2.440	2.000	10.25	10.62	12	1.000	13.00	24.2
	219.1	381.0	222.2	41.10	61.90	50.80	260.3	269.7				
10	10.75	17.50	10.88	1.880	2.620	2.190	12.62	12.75	16	1.120	15.25	34.1
	273.0	444.5	276.3	47.70	66.55	55.60	320.5	323.9				
12	12.75	20.50	12.94	2.000	2.880	2.380	14.75	15.00	16	1.250	17.75	49.8
	323.8	520.7	328.7	50.80	73.15	60.45	374.6	381.0				
14	14.00	23.00	14.19	2.120	3.000	2.500	16.75	16.25	20	1.250	20.25	69.9
	355.6	584.2	360.4	53.80	76.20	63.50	425.4	412.7				
16	16.00	25.50	16.19	2.250	3.250	2.690	19.00	18.50	20	1.380	22.50	88.1
	406.4	647.7	411.2	57.15	82.50	68.30	482.6	469.9				
18	18.00	28.00	18.19	2.380	3.500	2.750	21.00	21.00	24	1.380	24.75	109
	457.2	711.2	462.0	60.45	88.90	69.85	533.4	533.4				
20	20.00	30.50	20.19	2.500	3.750	2.880	23.12	23.00	24	1.380	27.00	134
	508.0	774.7	512.8	63.50	95.2	73.15	587.2	584.2				
24	24.00	36.00	24.19	2.750	4.190	3.250	27.62	27.25	24	1.620	32.00	201
	609.6	914.4	614.4	69.85	106.4	82.50	701.5	692.2				

Notes

- The thread conforms to ASME B1.20.1 NTP threads as described in Section 10. (The only exceptions are small male and female plain face threaded flanges which use NPSL locknut threads.)
- Class 300 and higher threaded flanges are counter-bored. Threads are chamfered to the counterbore at an angle of 45° (approx).
- Weights are based on manufacturer's data and are approximate.
- For tolerances see page 8-4.

Threaded Flanges - ANSI B16.5

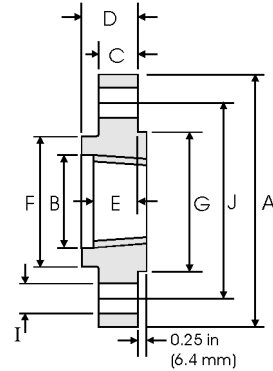

Class 400 lb

Pipe		Flange Data					Hub	Raised Face	Drilling Data			Weight
Nominal Pipe Size		A	B	C	D	E	F	G	H	I	J	
	Outside Diameter	Overall Diameter	Counter-bore min	Flange Thickness min	Overall Length	Threaded length min	Hub Diameter	Face Diameter	Number of Holes	Bolt Hole Diameter	Diameter of Circle of Holes	kg/ piece
	in mm	in mm	in mm	in mm	in mm	in mm	in mm	in mm		in mm	in mm	
1/2	0.840	3.750	0.930	0.560	0.880	0.620	1.500	1.380	4	0.620	2.620	0.74
	21.30	95.30	23.60	14.20	22.40	15.70	38.10	35.10		15.70	66.55	
3/4	1.050	4.620	1.140	0.620	1.000	0.620	1.880	1.690	4	0.750	3.250	1.27
	26.70	117.3	29.00	15.70	25.40	15.70	47.80	42.90		19.10	82.60	
1	1.315	4.880	1.410	0.690	1.060	0.690	2.120	2.000	4	0.750	3.500	1.52
	33.40	124.0	35.80	17.50	26.90	17.50	53.80	50.80		19.10	88.90	
1 1/4	1.660	5.250	1.750	0.810	1.120	0.810	2.500	2.500	4	0.750	3.880	2.03
	42.20	133.4	44.50	20.60	28.40	20.60	63.50	63.50		19.10	98.60	
1 1/2	1.900	6.120	1.990	0.880	1.250	0.880	2.750	2.880	4	0.880	4.500	2.96
	48.30	155.4	50.50	22.40	31.75	22.40	69.85	73.15		22.40	114.3	
2	2.375	6.500	2.500	1.000	1.440	1.120	3.310	3.620	8	0.750	5.000	3.62
	60.30	165.1	63.50	25.40	36.60	28.40	84.10	91.90		19.10	127.0	
2 1/2	2.875	7.500	3.000	1.120	1.620	1.250	3.940	4.120	8	0.880	5.880	5.28
	73.00	190.5	76.20	28.40	41.10	31.75	100.1	104.6		22.40	149.4	
3	3.500	8.250	3.630	1.250	1.810	1.380	4.620	5.000	8	0.880	6.620	7.00
	88.90	209.6	92.20	31.75	46.00	35.10	117.3	127.0		22.40	168.1	
3 1/2	4.000	9.000	4.130	1.380	1.940	1.560	5.250	5.500	8	1.000	7.250	8.84
	101.6	228.6	104.9	35.10	49.30	39.60	133.4	139.7		25.40	184.2	
4	4.500	10.00	4.630	1.380	2.000	1.440	5.750	6.190	8	1.000	7.880	11.1
	114.3	254.0	117.6	35.10	50.80	36.60	146.1	157.2		25.40	200.2	
5	5.563	11.00	5.690	1.500	2.120	1.690	7.000	7.310	8	1.000	9.250	13.9
	141.3	279.4	144.5	38.10	53.80	42.90	177.8	185.7		25.40	235.0	
6	6.625	12.50	6.750	1.620	2.250	1.810	8.120	8.500	12	1.000	10.62	18.3
	168.3	317.5	171.5	41.10	57.15	46.00	206.2	215.9		25.40	269.7	
8	8.625	15.00	8.750	1.880	2.690	2.000	10.25	10.62	12	1.120	13.00	28.6
	219.1	381.0	222.3	47.80	68.30	50.80	260.4	269.7		28.40	330.2	
10	10.75	17.50	10.88	2.120	2.880	2.190	12.62	12.75	16	1.250	15.25	39.2
	273.0	444.5	276.4	53.80	73.15	55.60	320.5	323.9		31.75	387.4	
12	12.75	20.50	12.94	2.250	3.120	2.380	14.75	15.00	16	1.380	17.75	57.0
	323.8	520.7	328.7	57.15	79.25	60.45	374.7	381.0		35.10	450.9	
14	14.00	23.00	14.19	2.380	3.310	2.500	16.75	16.25	20	1.380	20.25	79.1
	355.6	584.2	360.4	60.45	84.10	63.50	425.5	412.8		35.10	514.4	
16	16.00	25.50	16.19	2.500	3.690	2.690	19.00	18.50	20	1.500	22.50	101
	406.4	647.7	411.2	63.50	93.70	68.30	482.6	469.9		38.10	571.5	
18	18.00	28.00	18.19	2.620	3.880	2.750	21.00	21.00	24	1.500	24.75	123
	457.2	711.2	462.0	66.55	98.60	69.85	533.4	533.4		38.10	628.7	
20	20.00	30.50	20.19	2.750	4.000	2.880	23.12	23.00	24	1.620	27.00	146
	508.0	774.7	512.8	69.85	101.6	73.15	587.2	584.2		41.10	685.8	
24	24.00	36.00	24.19	3.000	4.500	3.250	27.62	27.25	24	1.880	32.00	219
	609.6	914.4	614.4	76.20	114.3	82.60	701.5	692.2		47.80	812.8	



Notes

- The thread conforms to ASME B1.20.1 NTP threads as described in Section 10. (The only exceptions are small male and female plain face threaded flanges which use NPSL locknut threads.)
- Class 300 and higher threaded flanges are counter-bored. Threads are chamfered to the counterbore at an angle of 45° (approx).
- Weights are based on manufacturer's data and are approximate.
- For tolerances see page 8-4.

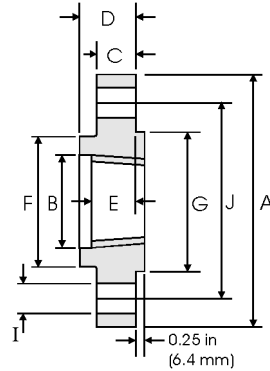
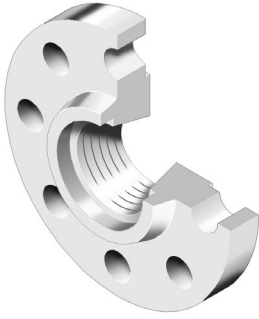
Threaded Flanges - ANSI B16.5



Class 600 lb

Pipe		Flange Data					Hub	Raised Face	Drilling Data			Weight
Nominal Pipe Size		A	B	C	D	E	F	G	H	I	J	
	Outside Diameter	Overall Diameter	Counter-bore min	Flange Thickness min	Overall Length	Threaded length min	Hub Diameter	Face Diameter	Number of Holes	Bolt Hole Diameter	Diameter of Circle of Holes	kg/ piece
in mm	in mm	in mm	in mm	in mm	in mm	in mm	in mm	in mm				
1/2	0.840	3.750	0.930	0.560	0.880	0.620	1.500	1.380	4	0.620	2.620	0.74
	21.30	95.20	23.60	14.20	22.40	15.70	38.10	35.10				
3/4	1.050	4.620	1.140	0.620	1.000	0.620	1.880	1.690	4	0.750	3.250	1.27
	26.70	117.3	29.00	15.70	25.40	15.70	47.80	42.90				
1	1.315	4.880	1.410	0.690	1.060	0.690	2.120	2.000	4	0.750	3.500	1.52
	33.40	124.0	35.80	17.50	26.90	17.50	53.80	50.80				
1 1/4	1.660	5.250	1.750	0.810	1.120	0.810	2.500	2.500	4	0.750	3.880	2.03
	42.20	133.4	44.50	20.60	28.40	20.60	63.50	63.50				
1 1/2	1.900	6.120	1.990	0.880	1.250	0.880	2.750	2.880	4	0.880	4.500	2.96
	48.30	155.4	50.50	22.40	31.75	22.40	69.85	73.15				
2	2.375	6.500	2.500	1.000	1.440	1.120	3.310	3.620	8	0.750	5.000	3.62
	60.30	165.1	63.50	25.40	36.60	28.40	84.10	91.90				
2 1/2	2.875	7.500	3.000	1.120	1.620	1.250	3.940	4.120	8	0.880	5.880	5.28
	73.00	190.5	76.20	28.40	41.10	31.75	100.1	104.6				
3	3.500	8.250	3.630	1.250	1.810	1.380	4.620	5.000	8	0.880	6.620	7.00
	88.90	209.6	92.20	31.75	46.00	35.10	117.3	127.0				
3 1/2	4.000	9.000	4.130	1.380	1.940	1.560	5.250	5.500	8	1.000	7.250	8.84
	101.6	228.6	104.9	35.10	49.30	39.60	133.4	139.7				
4	4.500	10.75	4.630	1.500	2.120	1.620	6.000	6.190	8	1.000	8.500	14.5
	114.3	273.1	117.6	38.10	53.80	41.10	152.4	157.2				
5	5.563	13.00	5.690	1.750	2.380	1.880	7.440	7.310	8	1.120	10.50	24.4
	141.3	330.2	144.5	44.50	60.45	47.80	189.0	185.7				
6	6.625	14.00	6.750	1.880	2.620	2.000	8.750	8.500	12	1.120	11.50	28.7
	168.3	355.6	171.5	47.80	66.55	50.80	222.3	215.9				
8	8.625	16.50	8.750	2.190	3.000	2.250	10.75	10.62	12	1.250	13.75	43.4
	219.1	419.1	222.3	55.60	76.20	57.15	273.1	269.7				
10	10.75	20.00	10.88	2.500	3.380	2.560	13.50	12.75	16	1.380	17.00	70.3
	273.0	508.0	276.4	63.50	85.90	65.00	342.9	323.9				
12	12.75	22.00	12.94	2.620	3.620	2.750	15.75	15.00	20	1.380	19.25	84.2
	323.8	558.8	328.7	66.55	91.90	69.85	400.1	381.0				
14	14.00	23.75	14.19	2.750	3.690	2.880	17.00	16.25	20	1.500	20.75	98.7
	355.6	603.3	360.4	69.85	93.70	73.15	431.8	412.8				
16	16.00	27.00	16.19	3.000	4.190	3.060	19.50	18.50	20	1.620	23.75	142
	406.4	685.8	411.2	76.20	106.4	77.70	495.3	469.9				
18	18.00	29.25	18.19	3.250	4.620	3.120	21.50	21.00	20	1.750	25.75	173
	457.2	743.0	462.0	82.60	117.3	79.25	546.1	533.4				
20	20.00	32.00	20.19	3.500	5.000	3.250	24.00	23.00	24	1.750	28.50	220
	508.0	812.8	512.8	88.90	127.0	82.60	609.6	584.2				
24	24.00	37.00	24.19	4.000	5.500	3.620	28.25	27.25	24	2.000	33.00	312
	609.6	939.8	614.4	101.6	139.7	91.90	717.6	692.2				

Notes

- The thread conforms to ASME B1.20.1 NTP threads as described in Section 10. (The only exceptions are small male and female plain face threaded flanges which use NPSL locknut threads.)
- Class 300 and higher threaded flanges are counter-bored. Threads are chamfered to the counterbore at an angle of 45° (approx).
- Weights are based on manufacturer's data and are approximate.
- For tolerances see page 8-4.

Threaded Flanges - ANSI B16.5

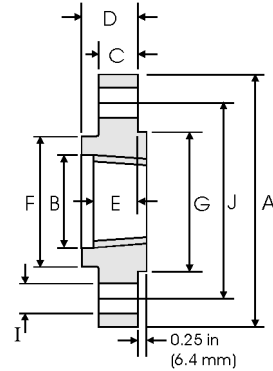

Class 900 lb

Nominal Pipe Size	Pipe	Flange Data					Hub	Raised Face	Drilling Data			Weight
		A	B	C	D	E	F	G	H	I	J	
	Outside Diameter	Diameter Overall	Counter-bore min	Flange Thickness min	Overall Length	Threaded length min	Hub Diameter	Face Diameter	Number of Holes	Bolt Hole Diameter	Diameter of Circle of Holes	kg/ piece
	in mm	in mm	in mm	in mm	in mm	in mm	in mm	in mm		in mm	in mm	
1/2	0.840	4.750	0.930	0.880	1.250	0.880	1.500	1.380	4	0.880	3.250	1.74
	21.30	120.6	23.60	22.30	31.70	22.30	38.10	35.10		22.30	82.50	
3/4	1.050	5.120	1.140	1.000	1.380	1.000	1.750	1.690	4	0.880	3.500	2.34
	26.70	130.0	29.00	25.40	35.00	25.40	44.40	42.90		22.30	88.90	
1	1.315	5.880	1.410	1.120	1.620	1.120	2.060	2.000	4	1.000	4.000	3.44
	33.40	149.3	35.80	28.40	41.10	28.40	52.30	50.80		25.40	101.6	
1 1/4	1.660	6.250	1.750	1.120	1.620	1.190	2.500	2.500	4	1.000	4.380	3.91
	42.20	158.7	44.40	28.40	41.10	30.20	63.50	63.50		25.40	111.2	
1 1/2	1.900	7.000	1.990	1.250	1.750	1.250	2.750	2.880	4	1.120	4.880	5.36
	48.30	177.8	50.50	31.70	44.50	31.70	69.85	73.15		28.40	123.9	
2	2.375	8.500	2.500	1.500	2.250	1.500	4.120	3.620	8	1.000	6.500	9.85
	60.30	215.9	63.50	38.10	57.15	38.10	104.6	91.90		25.40	165.1	
2 1/2	2.875	9.620	3.000	1.620	2.500	1.880	4.880	4.120	8	1.120	7.500	13.7
	73.00	244.3	76.20	41.10	63.50	47.70	123.9	104.6		28.40	190.5	
3	3.500	9.500	3.630	1.500	2.120	1.620	5.000	5.000	8	1.000	7.500	11.6
	88.90	241.3	92.20	38.10	53.80	41.10	127.0	127.0		25.40	190.5	
4	4.500	11.50	4.630	1.750	2.750	1.880	6.250	6.190	8	1.250	9.250	19.7
	114.3	292.1	117.6	44.40	69.85	47.80	158.7	157.2		31.70	234.9	
5	5.563	13.75	5.690	2.000	3.120	2.120	7.500	7.310	8	1.380	11.00	31.9
	141.3	349.2	144.5	50.80	79.25	53.80	190.5	185.7		35.00	279.4	
6	6.625	15.00	6.750	2.190	3.380	2.250	9.250	8.500	12	1.250	12.50	41.1
	168.3	381.0	171.4	55.60	85.80	57.15	234.9	215.9		31.70	317.5	
8	8.625	18.50	8.750	2.500	4.000	2.500	11.75	10.62	12	1.500	15.50	70.7
	219.1	469.9	222.2	63.50	101.6	63.50	298.4	269.7		38.10	393.7	
10	10.75	21.50	10.88	2.750	4.250	2.810	14.50	12.75	16	1.500	18.50	101
	273.0	546.1	276.3	69.85	107.9	71.40	368.3	323.9		38.10	469.9	
12	12.75	24.00	12.94	3.120	4.620	3.000	16.50	15.00	20	1.500	21.00	133
	323.8	609.6	328.7	79.40	117.3	76.20	419.1	381.0		38.10	533.4	
14	14.00	25.25	14.19	3.380	5.120	3.250	17.75	16.25	20	1.620	22.00	153
	355.6	641.3	360.4	85.70	130.0	82.50	450.8	412.7		41.10	558.8	
16	16.00	27.75	16.19	3.500	5.250	3.380	20.00	18.50	20	1.750	24.25	185
	406.4	704.8	411.2	88.90	133.3	85.90	508.0	469.9		44.40	618.9	
18	18.00	31.00	18.19	4.000	6.000	3.500	22.25	21.00	20	2.000	27.00	258
	457.2	787.4	462.0	101.6	152.4	88.90	565.1	533.4		50.80	685.8	
20	20.00	33.75	20.19	4.250	6.250	3.620	24.50	23.00	20	2.120	29.50	317
	508.0	857.2	512.8	107.9	158.7	91.90	622.3	584.2		53.80	749.3	
24	24.00	41.00	24.19	5.500	8.000	4.000	29.50	27.25	20	2.620	35.50	606
	609.6	1041.4	614.4	139.7	203.2	101.6	749.3	692.2		66.55	901.7	



Notes

- The thread conforms to ASME B1.20.1 NTP threads as described in Section 10. (The only exceptions are small male and female plain face threaded flanges which use NPSL locknut threads.)
- Class 300 and higher threaded flanges are counter-bored. Threads are chamfered to the counterbore at an angle of 45° (approx).
- Weights are based on manufacturer's data and are approximate.
- For tolerances see page 8-4.

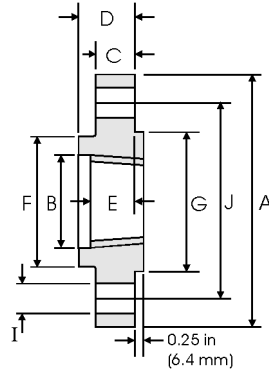
Threaded Flanges - ANSI B16.5



Class 1500 lb

Pipe		Flange Data					Hub	Raised Face	Drilling Data			Weight
Nominal Pipe Size		A	B	C	D	E	F	G	H	I	J	
	Outside Diameter	Overall Diameter	Counter-bore min	Flange Thickness min	Overall Length	Threaded length min	Hub Diameter	Face Diameter	Number of Holes	Bolt Hole Diameter	Diameter of Circle of Holes	kg/ piece
in mm	in mm	in mm	in mm	in mm	in mm	in mm	in mm	in mm		in mm	in mm	
1/2	0.840	4.750	0.930	0.880	1.250	0.880	1.500	1.380	4	0.880	3.250	1.74
	21.30	120.6	23.60	22.30	31.70	22.30	38.10	35.00		22.30	82.50	
3/4	1.050	5.120	1.140	1.000	1.380	1.000	1.750	1.690	4	0.880	3.500	2.34
	26.70	130.0	29.00	25.40	35.00	25.40	44.40	42.90		22.30	88.90	
1	1.315	5.880	1.410	1.120	1.620	1.120	2.060	2.000	4	1.000	4.000	3.44
	33.40	149.3	35.80	28.40	41.10	28.40	52.30	50.80		25.40	101.6	
1 1/4	1.660	6.250	1.750	1.120	1.620	1.190	2.500	2.500	4	1.000	4.380	3.91
	42.20	158.7	44.40	28.40	41.10	30.20	63.50	63.50		25.40	111.2	
1 1/2	1.900	7.000	1.990	1.250	1.750	1.250	2.750	2.880	4	1.120	4.880	5.36
	48.30	177.8	50.50	31.70	44.50	31.70	69.85	73.15		28.40	123.9	
2	2.375	8.500	2.500	1.500	2.250	1.500	4.120	3.620	8	1.000	6.500	9.85
	60.30	215.9	63.50	38.10	57.15	38.10	104.6	91.90		25.40	165.1	
2 1/2	2.875	9.620	3.000	1.620	2.500	1.880	4.880	4.120	8	1.120	7.500	13.7
	73.00	244.3	76.20	41.10	63.50	47.70	123.9	104.6		28.40	190.5	

Notes

- The thread conforms to ASME B1.20.1 NTP threads as described in Section 10. (The only exceptions are small male and female plain face threaded flanges which use NPSL locknut threads.)
- Class 300 and higher threaded flanges are counter-bored. Threads are chamfered to the counterbore at an angle of 45° (approx).
- Weights are based on manufacturer's data and are approximate.
- For tolerances see page 8-4.

Threaded Flanges - ANSI B16.5

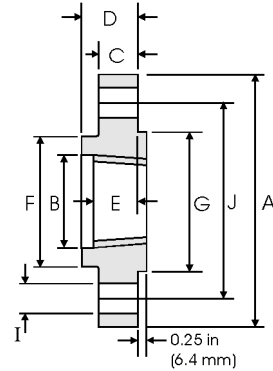
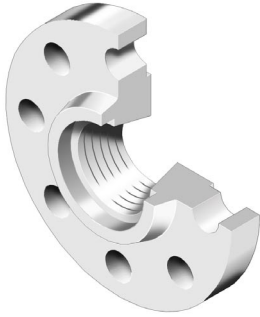

Class 2500 lb

Pipe		Flange Data					Hub	Raised Face	Drilling Data			Weight
Nominal Pipe Size		A	B	C	D	E	F	G	H	I	J	
	Outside Diameter	Overall Diameter	Counter-bore min	Flange Thickness min	Overall Length	Threaded length min	Hub Diameter	Face Diameter	Number of Holes	Bolt Hole Diameter	Diameter of Circle of Holes	kg/ piece
	in mm	in mm	in mm	in mm	in mm	in mm	in mm	in mm		in mm	in mm	
1/2	0.840	5.250	0.930	1.190	1.560	1.120	1.690	1.380	4	0.880	3.500	2.95
	21.30	133.4	23.60	30.20	39.60	28.40	42.90	35.10				
3/4	1.050	5.500	1.140	1.250	1.690	1.250	2.000	1.690	4	0.880	3.750	3.44
	26.70	139.7	29.00	31.75	42.90	31.75	50.80	42.90				
1	1.315	6.250	1.410	1.380	1.880	1.380	2.250	2.000	4	1.000	4.250	4.82
	33.40	158.8	35.80	35.10	47.80	35.10	57.15	50.80				
1 1/4	1.660	7.250	1.750	1.500	2.060	1.500	2.880	2.500	4	1.120	5.120	7.14
	42.20	184.2	44.50	38.10	52.30	38.10	73.15	63.50				
1 1/2	1.900	8.000	1.990	1.750	2.380	1.750	3.120	2.880	4	1.250	5.750	10.0
	48.30	203.2	50.50	44.50	60.45	44.50	79.25	73.15				
2	2.375	9.250	2.500	2.000	2.750	2.000	3.750	3.620	8	1.120	6.750	14.8
	60.30	235.0	63.50	50.80	69.85	50.80	95.30	91.90				
2 1/2	2.875	10.50	3.000	2.250	3.120	2.250	4.500	4.120	8	1.250	7.750	21.5
	73.00	266.7	76.20	57.15	79.25	57.15	114.3	104.6				

Notes

- The thread conforms to ASME B1.20.1 NTP threads as described in Section 10. (The only exceptions are small male and female plain face threaded flanges which use NPSL locknut threads.)
- Class 300 and higher threaded flanges are counter-bored. Threads are chamfered to the counterbore at an angle of 45° (approx).
- Weights are based on manufacturer's data and are approximate.
- For tolerances see page 8-4.

ASME B16.47 Series A (MSS SP-44) Flanges

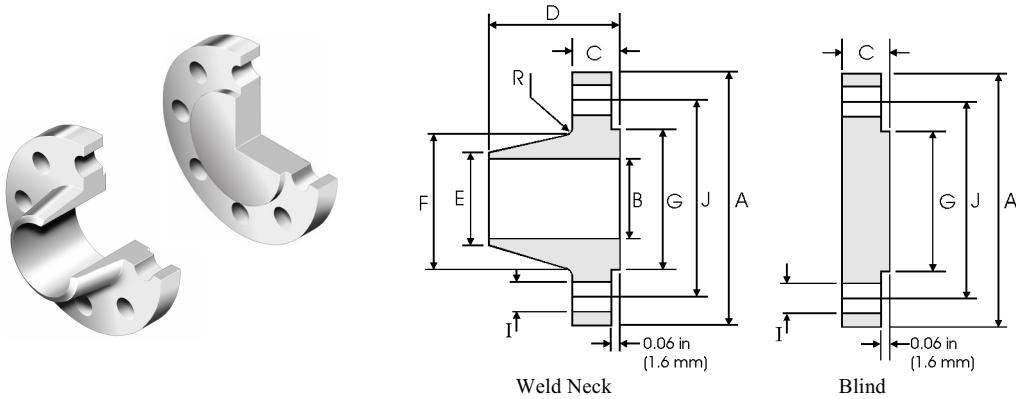

Class 150 lb

Pipe	Flange Data			Hub Data			Raised Face	Drilling Data			Radius
Nominal Pipe Size	A	C		D	E	F	G	H	I	J	R
	Overall Diameter	WNF Flange Thickness min	Blind Flange Thickness min	Overall Length WNF	Diameter at Weld Bevel	Hub Diameter	Face Diameter	Number of Holes	Bolt Hole Diameter	Diameter of Circle of Holes	Fillet
	in mm	in mm	in mm	in mm	in mm	in mm	in mm		in mm	in mm	in mm
22	29.50 749.30	1.81 45.97	1.81 45.97	5.88 149.35	22.00 558.80	24.00 609.60	25.25 641.35	20	1.38 35.05	27.25 692.15	0.38 9.65
26	34.25 869.95	2.69 68.33	2.69 68.33	4.75 120.65	26.00 660.40	26.62 676.15	29.50 749.30	24	1.38 35.05	31.75 806.45	0.38 9.65
28	36.50 927.10	2.81 71.37	2.81 71.37	4.94 125.48	28.00 711.20	28.62 726.95	31.50 800.10	28	1.38 35.05	34.00 863.60	0.44 11.18
30	38.75 984.25	2.94 74.68	2.94 74.68	5.38 136.65	30.00 762.00	30.75 781.05	33.75 857.25	28	1.38 35.05	36.00 914.40	0.44 11.18
32	41.75 1060.5	3.19 81.03	3.19 81.03	5.69 144.53	32.00 812.80	32.75 831.85	36.00 914.40	28	1.62 41.15	38.50 977.90	0.44 11.18
34	43.75 1111.3	3.25 82.55	3.25 82.55	5.88 149.35	34.00 863.60	34.75 882.65	38.00 965.20	32	1.62 41.15	40.50 1028.7	0.50 12.70
36	46.00 1168.4	3.56 90.42	3.56 90.42	6.19 157.23	36.00 914.40	36.75 933.45	40.25 1022.4	32	1.62 41.15	42.75 1085.9	0.50 12.70
38	48.75 1238.3	3.44 87.38	3.44 87.38	6.19 157.23	38.00 965.20	39.00 990.60	42.25 1073.2	32	1.62 41.15	45.25 1149.4	0.50 12.70
40	50.75 1289.1	3.56 90.42	3.56 90.42	6.44 163.58	40.00 1016.0	41.00 1041.4	44.25 1124.0	36	1.62 41.15	47.25 1200.2	0.50 12.70
42	53.00 1346.2	3.81 96.77	3.81 96.77	6.75 171.45	42.00 1066.8	43.00 1092.2	47.00 1193.8	36	1.62 41.15	49.50 1257.3	0.50 12.70
44	55.25 1403.4	4.00 101.60	4.00 101.60	7.00 177.80	44.00 1117.6	45.00 1143.0	49.00 1244.6	40	1.62 41.15	51.75 1314.5	0.50 12.70
46	57.25 1454.2	4.06 103.12	4.06 103.12	7.31 185.67	46.00 1168.4	47.12 1196.9	51.00 1295.4	40	1.62 41.15	53.75 1365.3	0.50 12.70
48	59.50 1511.3	4.25 107.95	4.25 107.95	7.56 192.02	48.00 1219.2	49.12 1247.7	53.50 1358.9	44	1.62 41.15	56.00 1422.4	0.50 12.70

Notes

- ASME B16.47 Series A flanges (≥ NPS 26) are MSS SP-44 flanges. MSS SP-44 also covers NPS 12 to NPS 24 flanges which are equivalent to ASME B16.5. MSS SP-44 is the only source for the NPS 22 flange dimensions above.
- Dimension B is to be specified by the purchaser. It corresponds to the pipe inside diameter.
- Flat face flanges may be provided at full thickness, C, or with raised face removed (the latter is nonstandard).
- WNF = Weld Neck Flange.
- The large end of the hub may be straight or tapered.
- For ring joint facings see page 8-6. For weld end bevel see page 8-5.
- For tolerances see page 8-4.

ASME B16.47 Series A (MSS SP-44) Flanges

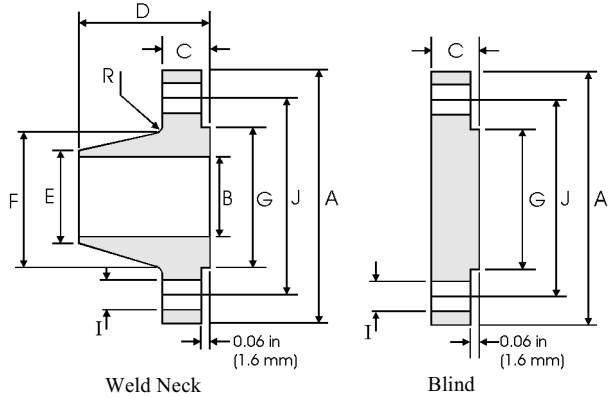
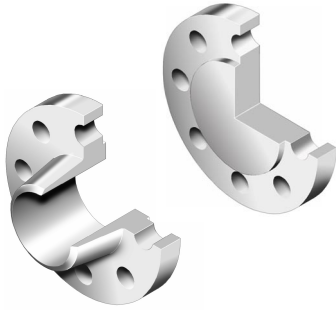

Class 300 lb

Pipe	Flange Data			Hub Data		Raised Face	Drilling Data			Radius	
Nominal Pipe Size	A	C	D	E	F	G	H	I	J	R	
	Overall Diameter	WNF Flange Thickness min	Blind Flange Thickness min	Overall Length WNF	Diameter at Weld Bevel	Hub Diameter	Face Diameter	Number of Holes	Bolt Hole Diameter	Diameter of Circle of Holes	Fillet
	in mm	in mm	in mm	in mm	in mm	in mm	in mm		in mm	in mm	in mm
22	33.00 838.20	2.62 66.55	2.62 66.55	6.50 165.10	22.00 558.80	25.25 641.35	25.25 641.35	24	1.62 41.15	29.25 742.95	0.38 9.65
26	38.25 971.55	3.12 79.25	3.31 84.07	7.25 184.15	26.00 660.40	28.38 720.85	29.50 749.30	28	1.75 44.45	34.50 876.30	0.38 9.65
28	40.75 1035.1	3.38 85.85	3.56 90.42	7.75 196.85	28.00 711.20	30.50 774.70	31.50 800.10	28	1.75 44.45	37.00 939.80	0.44 11.18
30	43.00 1092.2	3.62 91.95	3.75 95.25	8.25 209.55	30.00 762.00	32.56 827.02	33.75 857.25	28	1.88 47.75	39.25 996.95	0.44 11.18
32	45.25 1149.4	3.88 98.55	3.94 100.08	8.75 222.25	32.00 812.80	34.69 881.13	36.00 914.40	28	2.00 50.80	41.50 1054.1	0.44 11.18
34	47.50 1205.0	4.00 101.60	4.12 104.65	9.12 231.65	34.00 863.60	36.88 936.75	38.00 965.20	28	2.00 50.80	43.50 1104.9	0.50 12.70
36	50.00 1270.0	4.12 104.65	4.38 111.25	9.50 241.30	36.00 914.40	39.00 990.60	40.25 1022.4	32	2.12 53.85	46.00 1168.4	0.50 12.70
38	46.00 1168.4	4.25 107.95	4.25 107.95	7.12 180.85	38.00 965.20	39.12 993.65	40.50 1028.7	32	1.62 41.15	43.00 1092.2	0.50 12.70
40	48.75 1238.3	4.50 114.30	4.50 114.30	7.62 193.55	40.00 1016.0	41.25 1047.8	42.75 1085.9	32	1.75 44.45	45.50 1155.7	0.50 12.70
42	50.75 1289.1	4.69 119.13	4.69 119.13	7.88 200.15	42.00 1066.8	43.25 1098.6	44.75 1136.7	32	1.75 44.45	47.50 1206.6	0.50 12.70
44	53.25 1352.6	4.88 123.95	4.88 123.95	8.12 206.25	44.00 1117.6	45.25 1149.4	47.00 1193.8	32	1.88 47.75	49.75 1263.7	0.50 12.70
46	55.75 1416.1	5.06 128.52	5.06 128.52	8.50 215.90	46.00 1168.4	47.38 1203.5	49.00 1244.0	28	2.00 50.80	52.00 1320.8	0.50 12.70
48	57.75 1466.9	5.25 133.35	5.25 133.35	8.81 223.77	48.00 1219.2	49.38 1254.3	51.25 1301.8	32	2.00 50.80	54.00 1371.6	0.50 12.70

Notes

- ASME B16.47 Series A flanges (≥ NPS 26) are MSS SP-44 flanges. MSS SP-44 also covers NPS 12 to NPS 24 flanges which are equivalent to ASME B16.5. MSS SP-44 is the only source for the NPS 22 flange dimensions above.
- Dimension B is to be specified by the purchaser. It corresponds to the pipe inside diameter.
- Flat face flanges may be provided at full thickness, C, or with raised face removed (the latter is nonstandard).
- WNF = Weld Neck Flange.
- The large end of the hub may be straight or tapered.
- For ring joint facings see page 8-6. For weld end bevel see page 8-5.
- For tolerances see page 8-4.

ASME B16.47 Series A (MSS SP-44) Flanges

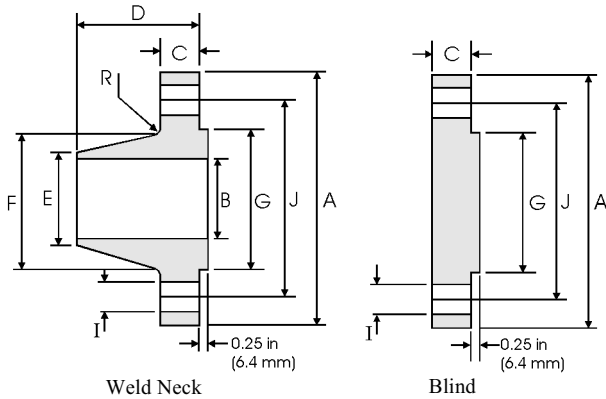
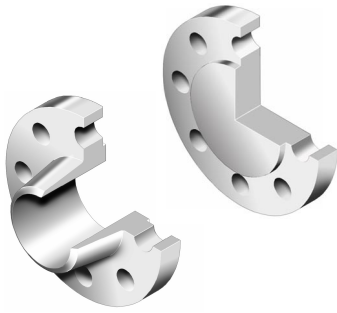

Class 400 lb

Pipe	Flange Data			Hub Data			Raised Face	Drilling Data			Radius
Nominal Pipe Size	A	C		D	E	F	G	H	I	J	R
	Overall Diameter	WNF Flange Thickness min	Blind Flange Thickness min	Overall Length WNF	Diameter at Weld Bevel	Hub Diameter	Face Diameter	Number of Holes	Bolt Hole Diameter	Diameter of Circle of Holes	Fillet
	in mm	in mm	in mm	in mm	in mm	in mm	in mm		in mm	in mm	in mm
22	33.00 838.20	2.88 73.15	2.88 73.15	6.75 171.45	22.00 558.80	25.25 641.35	25.25 641.35	24	1.75 44.45	29.25 742.95	0.44 11.18
26	38.25 971.55	3.50 88.90	3.88 98.55	7.62 193.55	26.00 660.40	28.62 726.95	29.50 749.30	28	1.88 47.75	34.50 876.30	0.44 11.18
28	40.75 1035.1	3.75 95.25	4.12 104.65	8.12 206.25	28.00 711.20	30.81 782.57	31.50 800.10	28	2.00 50.80	37.00 939.80	0.50 12.70
30	43.00 1092.2	4.00 101.60	4.38 111.25	8.62 218.95	30.00 762.00	32.94 836.68	33.75 857.25	28	2.12 53.85	39.25 996.95	0.50 12.70
32	45.25 1149.4	4.25 107.95	4.56 115.82	9.12 231.65	32.00 812.80	35.00 889.00	36.00 914.40	28	2.12 53.85	41.50 1054.1	0.50 12.70
34	47.50 1206.5	4.38 111.25	4.81 122.17	9.50 241.30	34.00 863.60	37.19 944.63	38.00 965.20	28	2.12 53.85	43.50 1104.9	0.56 14.22
36	50.00 1270.0	4.50 114.30	5.06 128.52	9.88 250.95	36.00 914.40	39.38 1000.3	40.25 1022.4	32	2.12 53.85	46.00 1168.4	0.56 14.22
38	47.50 1206.5	4.88 123.95	4.88 123.95	8.12 206.25	48.00 1219.2	39.50 1003.3	40.75 1035.1	32	1.88 47.75	44.00 1117.6	0.56 14.22
40	50.00 1270.0	5.12 130.05	5.12 130.05	8.50 215.90	40.00 1016.0	41.50 1054.1	43.00 1092.2	32	2.00 50.80	46.25 1174.8	0.56 14.22
42	52.00 1320.8	5.25 133.35	5.25 133.35	8.81 223.77	42.00 1066.8	43.62 1107.9	45.00 1143.0	32	2.00 50.80	48.25 1225.6	0.56 14.22
44	54.50 1384.3	5.50 139.70	5.50 139.70	9.18 233.17	44.00 1117.6	45.62 1158.7	47.25 1200.2	32	2.12 53.85	50.50 1282.7	0.56 14.22
46	56.75 1441.5	5.75 146.05	5.75 146.05	9.62 244.35	46.00 1168.4	47.75 1212.9	49.50 1257.3	36	2.12 53.85	52.75 1339.9	0.56 14.22
48	59.50 1511.3	6.00 152.40	6.00 152.40	10.12 257.05	48.00 1219.2	49.88 1267.0	51.50 1308.1	28	2.38 60.45	55.25 1403.4	0.56 14.22

Notes

- ASME B16.47 Series A flanges (\geq NPS 26) are MSS SP-44 flanges. MSS SP-44 also covers NPS 12 to NPS 24 flanges which are equivalent to ASME B16.5. MSS SP-44 is the only source for the NPS 22 flange dimensions above.
- Class 400 Series A dimensions at NPS 38 and larger also apply to Class 400 Series B flanges.
- Dimension B is to be specified by the purchaser. It corresponds to the pipe inside diameter.
- Flat face flanges may be provided at full thickness, C + raised face, or with raised face removed (the latter is nonstandard).
- WNF = Weld Neck Flange.
- The large end of the hub may be straight or tapered.
- For ring joint facings see page 8-6. For weld end bevel see page 8-5.
- For tolerances see page 8-4.

ASME B16.47 Series A (MSS SP-44) Flanges

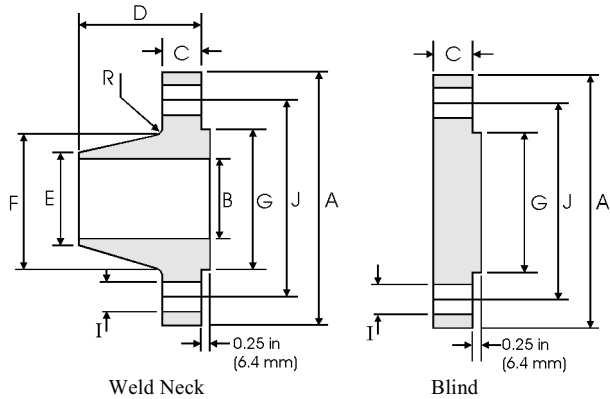
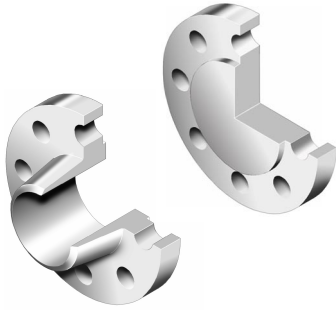

Class 600 lb

Pipe	Flange Data			Hub Data		Raised Face	Drilling Data			Radius	
Nominal Pipe Size	A	C	D	E	F	G	H	I	J	R	
	Overall Diameter	WNF Flange Thickness min	Blind Flange Thickness min	Overall Length WNF	Diameter at Weld Bevel	Hub Diameter	Face Diameter	Number of Holes	Bolt Hole Diameter	Diameter of Circle of Holes	Fillet
	in mm	in mm	in mm	in mm	in mm	in mm	in mm		in mm	in mm	in mm
22	34.25 869.95	3.75 95.25	3.75 95.25	7.75 196.85	22.00 558.80	26.25 666.75	25.25 641.35	24	1.88 47.75	30.62 777.75	0.44 11.18
26	40.00 1016.0	4.25 107.95	4.94 125.48	8.75 222.25	26.00 660.40	29.44 747.78	29.50 749.30		28	2.00 50.80	36.00 914.40
28	42.25 1073.2	4.38 111.25	5.19 131.83	9.25 234.95	28.00 711.20	31.62 803.15	31.50 800.10	28	2.12 53.85	38.00 965.20	0.50 12.70
30	44.50 1130.3	4.50 114.30	5.50 139.70	9.75 247.65	30.00 762.00	33.94 862.08	33.75 857.25	28	2.12 53.85	40.25 1022.4	0.50 12.70
32	47.00 1193.8	4.62 117.35	5.81 147.57	10.25 260.35	32.00 812.80	36.12 917.45	36.00 914.40	28	2.38 60.45	42.50 1079.5	0.50 12.70
34	49.00 1244.6	4.75 120.65	6.06 153.92	10.62 269.75	34.00 863.60	38.31 973.07	38.00 965.20	28	2.38 60.45	44.50 1130.3	0.56 14.22
36	51.75 1314.5	4.88 123.95	6.38 162.05	11.12 282.45	36.00 914.40	40.62 1031.75	40.25 1022.35	28	2.62 66.55	47.00 1193.0	0.56 14.22
38	50.00 1270.0	6.00 152.40	6.12 155.45	10.00 254.00	38.00 965.20	40.25 1022.35	41.50 1054.10	28	2.38 60.45	45.75 1162.1	0.56 14.22
40	52.00 1320.8	6.25 158.75	6.38 162.05	10.38 263.65	40.00 1016.0	42.25 1073.2	43.75 1111.3	32	2.38 60.45	47.75 1212.9	0.56 14.22
42	55.25 1403.4	6.62 168.15	6.75 171.45	11.00 279.40	42.00 1066.8	44.38 1127.3	46.00 1168.4	28	2.62 66.55	50.50 1282.7	0.56 14.22
44	57.25 1454.2	6.81 172.97	7.00 177.80	11.38 289.05	44.00 1117.6	46.50 1181.1	48.25 1225.6	32	2.62 66.55	52.50 1333.5	0.56 14.22
46	59.50 1511.3	7.06 179.32	7.31 185.67	11.81 299.97	46.00 1168.4	48.62 1235.0	50.25 1276.4	32	2.62 66.55	54.75 1390.7	0.56 14.22
48	62.75 1593.9	7.44 188.98	7.69 195.33	12.44 315.98	48.00 1219.2	50.75 1289.1	52.50 1333.5	32	2.88 73.15	57.50 1460.5	0.56 14.22

Notes

- ASME B16.47 Series A flanges (≥ NPS 26) are MSS SP-44 flanges. MSS SP-44 also covers NPS 12 to NPS 24 flanges which are equivalent to ASME B16.5. MSS SP-44 is the only source for the NPS 22 flange dimensions above.
- Class 600 Series A dimensions at NPS 38 and larger also apply to Class 600 Series B flanges.
- Dimension B is to be specified by the purchaser. It corresponds to the pipe inside diameter.
- Flat face flanges may be provided at full thickness, C + raised face, or with raised face removed (the latter is nonstandard).
- WNF = Weld Neck Flange.
- The large end of the hub may be straight or tapered.
- For ring joint facings see page 8-6. For weld end bevel see page 8-5.
- For tolerances see page 8-4.

ASME B16.47 Series A (MSS SP-44) Flanges

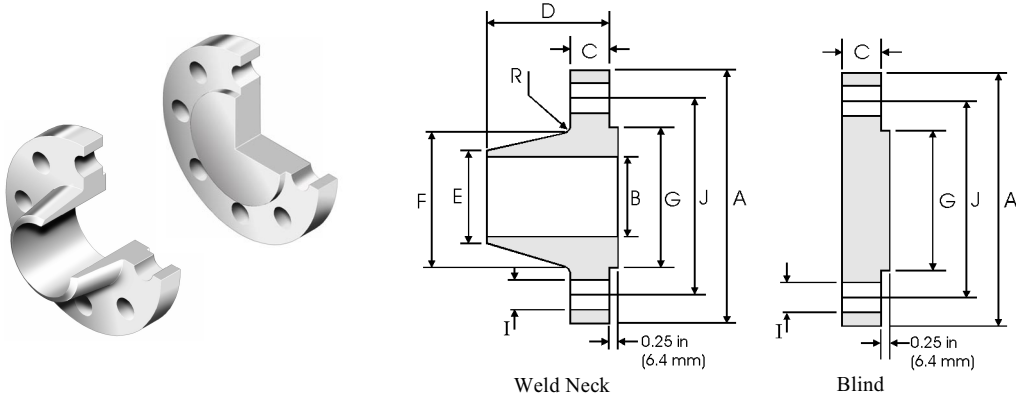

Class 900 lb

Pipe	Flange Data			Hub Data			Raised Face	Drilling Data			Radius
Nominal Pipe Size	A	C	D	E	F	G	H	I	J	R	
	Overall Diameter	WNF Flange Thickness min	Blind Flange Thickness min	Overall Length WNF	Diameter at Weld Bevel	Hub Diameter	Face Diameter	Number of Holes	Bolt Hole Diameter	Diameter of Circle of Holes	Fillet
	in mm	in mm	in mm	in mm	in mm	in mm	in mm		in mm	in mm	in mm
26	42.75 1085.9	5.50 139.70	6.31 160.27	11.25 285.75	26.00 660.40	30.50 774.70	29.50 749.30	20	2.88 73.15	37.50 952.50	0.44 11.18
28	46.00 1168.4	5.62 142.75	6.75 171.45	11.75 298.45	28.00 711.20	32.75 831.85	31.50 800.10	20	3.12 79.25	40.25 1022.4	0.50 12.70
30	48.50 1231.9	5.88 149.35	7.18 182.37	12.25 311.15	30.00 762.00	35.00 889.00	33.75 857.25	20	3.12 79.25	42.75 1085.9	0.50 12.70
32	51.75 1314.5	6.25 158.75	7.62 193.55	13.00 330.20	32.00 812.80	37.25 946.15	36.00 914.40	20	3.38 85.85	45.50 1155.7	0.50 12.70
34	55.00 1397.0	6.50 165.10	8.06 204.72	13.75 349.25	34.00 863.60	39.62 1006.4	38.00 965.20	20	3.62 91.95	48.25 1225.6	0.56 14.22
36	57.50 1460.5	6.75 171.45	8.44 214.38	14.25 361.95	36.00 914.40	41.88 1063.8	40.25 1022.4	20	3.62 91.95	50.75 1289.1	0.56 14.22
38	57.50 1460.5	7.50 190.50	8.50 215.90	13.88 352.55	38.00 965.20	42.25 1073.2	43.25 1098.6	20	3.62 91.95	50.75 1289.1	0.75 19.05
40	59.50 1511.3	7.75 196.85	8.81 223.77	14.31 363.47	40.00 1016.0	44.38 1127.3	45.75 1162.1	24	3.62 91.95	52.75 1339.9	0.81 20.57
42	61.50 1562.1	8.12 206.25	9.12 231.65	14.62 371.35	42.00 1066.8	46.31 1176.3	47.75 1212.9	24	3.62 91.95	54.75 1390.7	0.81 20.57
44	64.88 1648.0	8.44 214.38	9.56 242.82	15.38 390.65	44.00 1117.6	48.62 1235.0	50.00 1270.0	24	3.88 98.55	57.62 1463.6	0.88 22.35
46	68.25 1733.6	8.88 225.55	10.06 255.52	16.18 410.97	46.00 1168.4	50.88 1292.4	52.50 1333.5	24	4.12 104.65	60.50 1536.7	0.88 22.35
48	70.25 1784.4	9.19 233.43	10.38 263.65	16.50 419.10	48.00 1219.2	52.88 1343.2	54.50 1384.3	24	4.12 104.65	62.50 1587.5	0.94 23.88

Notes

- ASME B16.47 Series A flanges (≥ NPS 26) are MSS SP-44 flanges. MSS SP-44 also covers NPS 12 to NPS 24 flanges which are equivalent to ASME B16.5. MSS SP-44 is the only source for the NPS 22 flange dimensions above.
- Class 900 Series A dimensions at NPS 38 and larger also apply to Class 900 Series B flanges.
- Dimension B is to be specified by the purchaser. It corresponds to the pipe inside diameter.
- Flat face flanges may be provided at full thickness, C + raised face, or with raised face removed (the latter is nonstandard).
- WNF = Weld Neck Flange.
- The large end of the hub may be straight or tapered.
- For ring joint facings see page 8-6. For weld end bevel see page 8-5.
- For tolerances see page 8-4.

ASME B16.47 Series B (API 605) Flanges

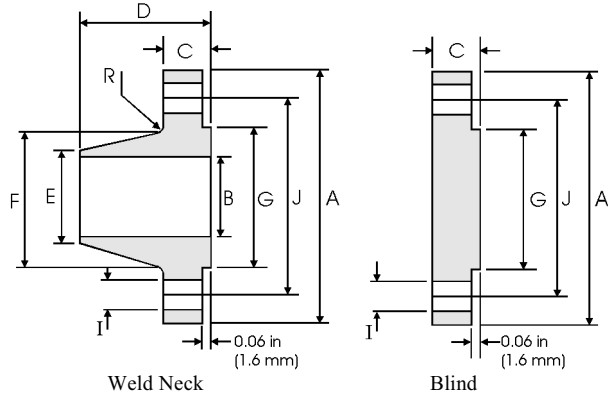
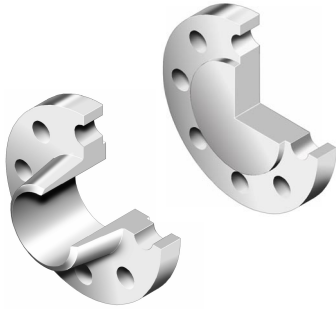

Class 75 lb

Pipe	Flange Data			Hub Data			Raised Face	Drilling Data			Radius
Nominal Pipe Size	A	C		D	E	F	G	H	I	J	R
	Overall Diameter	WNF Flange Thickness min	Blind Flange Thickness min	Overall Length WNF	Diameter at Weld Bevel	Hub Diameter	Face Diameter	Number of Holes	Bolt Hole Diameter	Diameter of Circle of Holes	Fillet
	in mm	in mm	in mm	in mm	in mm	in mm	in mm		in mm	in mm	in mm
26	30.00 762.00	1.31 33.27	1.31 33.27	2.31 58.67	26.06 661.92	26.62 676.15	27.75 704.85	36	0.75 19.05	28.50 723.90	0.31 7.87
28	32.00 812.80	1.31 33.27	1.31 33.27	2.44 61.98	28.06 712.72	28.62 726.95	29.75 755.65	40	0.75 19.05	30.50 774.70	0.31 7.87
30	34.00 863.60	1.31 33.27	1.31 33.27	2.56 65.02	30.06 763.52	30.62 777.75	31.75 806.45	44	0.75 19.05	32.50 825.50	0.31 7.87
32	36.00 914.40	1.38 35.05	1.44 36.58	2.75 69.85	32.06 814.32	32.62 828.55	33.75 857.25	48	0.75 19.05	34.50 876.30	0.31 7.87
34	38.00 965.20	1.38 35.05	1.50 38.10	2.88 73.15	34.06 865.12	34.62 879.35	35.75 908.05	52	0.75 19.05	36.50 927.10	0.31 7.87
36	40.69 1033.5	1.44 36.58	1.67 42.42	3.38 85.85	36.06 915.92	36.81 934.97	38.00 965.20	40	0.88 22.35	39.06 992.12	0.38 9.65
38	42.69 1084.3	1.50 38.10	1.75 44.45	3.50 88.90	38.06 966.72	38.81 985.77	40.00 1016.0	40	0.88 22.35	41.06 1042.9	0.38 9.65
40	44.69 1135.1	1.50 38.10	1.75 44.45	3.62 91.95	40.06 1017.5	40.81 1036.57	42.0 1066.8	44	0.88 22.35	43.06 1093.7	0.38 9.65
42	46.69 1185.9	1.56 39.62	1.88 47.75	3.75 95.25	42.06 1068.3	42.81 1087.37	44.00 1117.6	48	0.88 22.35	45.06 1144.5	0.38 9.65
44	49.25 1251.0	1.69 42.93	1.94 49.28	4.12 104.65	44.06 1119.1	44.88 1139.95	46.25 1174.8	36	1.00 25.40	47.38 1203.5	0.38 9.65
46	51.25 1301.8	1.75 44.45	2.00 50.80	4.25 107.95	46.06 1169.9	46.88 1190.75	48.25 1225.6	40	1.00 25.40	49.38 1254.3	0.38 9.65
48	53.25 1352.6	1.81 45.97	2.12 53.85	4.38 111.25	48.06 1220.7	48.88 1241.55	50.25 1276.4	44	1.00 25.40	51.38 1305.1	0.38 9.65

Notes

- ASME B16.47 Series B flanges are API 605 flanges. API 605 has been cancelled.
- Class 400 Series A dimensions at NPS 38 and larger also apply to Class 400 Series B flanges.
- Dimension B is to be specified by the purchaser. It corresponds to the pipe inside diameter.
- Flat face flanges may be provided at full thickness, C, or with raised face removed (the latter is nonstandard).
- WNF = Weld Neck Flange.
- The large end of the hub may be straight or tapered.
- For ring joint facings see page 8-6. For weld end bevel see page 8-5.
- For tolerances see page 8-4.

ASME B16.47 Series B (API 605) Flanges

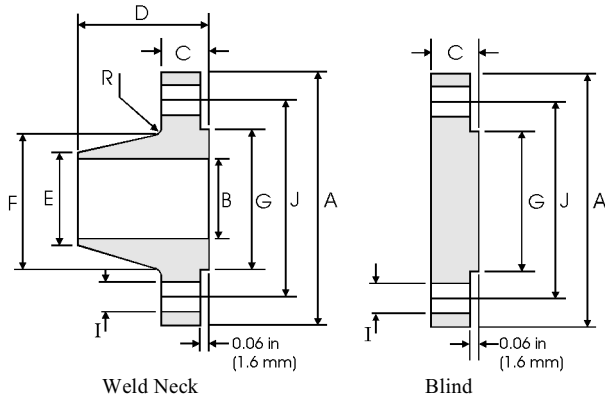

Class 150 lb

Pipe	Flange Data			Hub Data		Raised Face	Drilling Data			Radius	
Nominal Pipe Size	A	C		D	E	F	G	H	I	J	R
	Overall Diameter	WNF Flange Thickness min	Blind Flange Thickness min	Overall Length WNF	Diameter at Weld Bevel	Hub Diameter	Face Diameter	Number of Holes	Bolt Hole Diameter	Diameter of Circle of Holes	Fillet
	in mm	in mm	in mm	in mm	in mm	in mm	in mm				
26	30.94 785.88	1.62 41.15	1.75 44.45	3.50 88.90	26.06 661.92	26.94 684.28	28.00 711.20	36	0.88 22.35	29.31 744.47	0.38 9.65
28	32.94 836.68	1.75 44.45	1.88 47.75	3.75 95.25	28.06 712.72	28.94 735.08	30.00 762.00		40	0.88 22.35	31.31 795.27
30	34.94 887.48	1.75 44.45	2.00 50.80	3.94 100.08	30.06 763.52	31.00 787.40	32.00 812.80	44	0.88 22.35	33.31 846.07	0.38 9.65
32	37.06 941.32	1.81 45.97	2.12 53.85	4.25 107.95	32.06 814.32	33.06 839.72	34.00 863.60	48	0.88 22.35	35.44 900.18	0.38 9.65
34	39.56 1004.8	1.94 49.28	2.25 57.15	4.34 110.24	34.06 865.12	35.12 892.05	36.25 920.75	40	1.00 25.40	37.69 957.33	0.38 9.65
36	41.62 1057.1	2.06 52.32	2.31 58.67	4.62 117.35	36.06 915.92	37.19 944.63	38.25 971.55	44	1.00 25.40	39.75 1009.7	0.38 9.65
38	44.25 1124.0	2.12 53.85	2.50 63.50	4.88 123.95	38.12 968.25	39.25 996.95	40.25 1022.4	40	1.12 28.45	42.12 1069.8	0.38 9.65
40	46.25 1174.8	2.19 55.63	2.62 66.55	5.06 128.52	40.12 1019.0	41.31 1049.3	42.50 1079.5	44	1.12 28.45	44.12 1120.6	0.38 9.65
42	48.25 1225.6	2.31 58.67	2.69 68.33	5.25 133.35	42.12 1069.8	43.38 1101.9	44.50 1130.3	48	1.12 28.45	46.12 1171.4	0.44 11.18
44	50.25 1276.4	2.38 60.45	2.81 71.37	5.38 136.65	44.12 1120.6	45.38 1152.7	46.50 1181.1	52	1.12 28.45	48.12 1222.2	0.44 11.18
46	52.81 1341.4	2.44 61.98	2.94 74.68	5.69 144.53	46.12 1171.4	47.44 1205.0	48.62 1234.9	40	1.25 31.75	50.56 1284.2	0.44 11.18
48	54.81 1392.2	2.56 65.02	3.06 77.72	5.88 149.35	48.12 1222.2	49.50 1257.3	50.75 1289.1	44	1.25 31.75	52.56 1335.0	0.44 11.18

Notes

- ASME B16.47 Series B flanges are API 605 flanges. API 605 has been cancelled.
- Dimension B is to be specified by the purchaser. It corresponds to the pipe inside diameter.
- Flat face flanges may be provided at full thickness, C, or with raised face removed (the latter is nonstandard).
- WNF = Weld Neck Flange.
- The large end of the hub may be straight or tapered.
- For ring joint facings see page 8-6. For weld end bevel see page 8-5.
- For tolerances see page 8-4.

ASME B16.47 Series B (API 605) Flanges

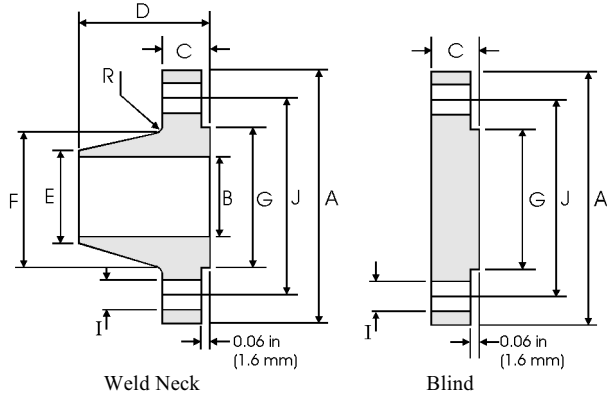
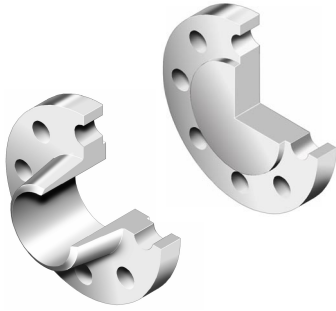

Class 300 lb

Pipe	Flange Data			Hub Data		Raised Face	Drilling Data			Radius	
Nominal Pipe Size	A	C		D	E	F	G	H	I	J	R
	Overall Diameter	WNF Flange Thickness min	Blind Flange Thickness min	Overall Length WNF	Diameter at Weld Bevel	Hub Diameter	Face Diameter	Number of Holes	Bolt Hole Diameter	Diameter of Circle of Holes	Fillet
	in mm	in mm	in mm	in mm	in mm	in mm	in mm		in mm	in mm	in mm
26	34.12 866.65	3.50 88.90	3.50 88.90	5.69 144.53	26.19 665.23	27.62 701.55	29.00 736.60	32	1.38 35.05	31.62 803.15	0.56 14.22
28	36.25 920.75	3.50 88.90	3.50 88.90	5.88 149.35	28.19 716.03	29.75 755.65	31.00 787.40	36	1.38 35.05	33.75 857.25	0.56 14.22
30	39.00 990.60	3.69 93.73	3.69 93.73	6.22 157.99	30.25 768.35	32.00 812.80	33.25 844.55	36	1.50 38.10	36.25 920.75	0.56 14.22
32	41.50 1054.1	4.06 103.12	4.06 103.12	6.62 168.15	32.25 819.15	34.00 863.60	35.50 901.70	32	1.62 41.15	38.50 977.90	0.62 15.75
34	43.62 1107.9	4.06 103.12	4.06 103.12	6.81 172.97	34.25 869.95	36.12 917.45	37.50 952.50	36	1.62 41.15	40.62 1031.7	0.62 15.75
36	46.12 1171.4	4.06 103.12	4.06 103.12	7.12 180.85	36.25 920.75	38.00 965.20	39.75 1009.7	32	1.75 44.45	42.88 1089.2	0.62 15.75
38	48.12 1222.2	4.38 111.25	4.38 111.25	7.56 192.02	38.25 971.55	40.00 1016.0	41.75 1060.5	36	1.75 44.45	44.88 1140.0	0.62 15.75
40	50.12 1273.0	4.56 115.82	4.56 115.82	7.81 198.37	40.25 1022.4	42.00 1066.8	43.88 1114.6	40	1.75 44.45	46.88 1190.8	0.62 15.75
42	52.50 1333.5	4.69 119.13	4.69 119.13	8.06 204.72	42.31 1074.7	44.00 1117.6	46.00 1168.4	36	1.88 47.75	49.00 1244.6	0.62 15.75
44	54.50 1384.3	5.00 127.00	5.00 127.00	8.44 214.38	44.31 1125.5	46.19 1173.2	48.00 1219.2	40	1.88 47.75	51.00 1295.4	0.62 15.75
46	57.50 1460.5	5.06 128.52	5.12 130.05	8.75 222.25	46.31 1176.3	48.38 1228.9	50.00 1270.0	36	2.00 50.80	53.75 1365.3	0.62 15.75
48	59.50 1511.3	5.06 128.52	5.31 134.87	8.81 223.77	48.31 1227.1	50.31 1277.9	52.25 1327.2	40	2.00 50.80	55.75 1416.1	0.62 15.75

Notes

- ASME B16.47 Series B flanges are API 605 flanges. API 605 has been cancelled.
- Dimension B is to be specified by the purchaser. It corresponds to the pipe inside diameter.
- Flat face flanges may be provided at full thickness, C, or with raised face removed (the latter is nonstandard).
- WNF = Weld Neck Flange.
- The large end of the hub may be straight or tapered.
- For ring joint facings see page 8-6. For weld end bevel see page 8-5.
- For tolerances see page 8-4.

ASME B16.47 Series B (API 605) Flanges

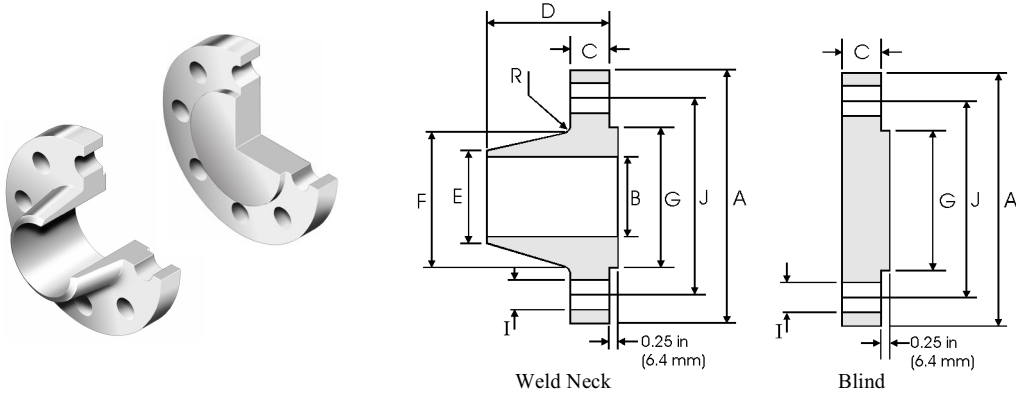

Class 400 lb, 600 lb and 900 lb

Pipe	Flange Data			Hub Data			Raised Face	Drilling Data			Radius
Nominal Pipe Size	A	C	D	E	F	G	H	I	J	R	
	Overall Diameter	WNF Flange Thickness min	Blind Flange Thickness min	Overall Length WNF	Diameter at Weld Bevel	Hub Diameter	Face Diameter	Number of Holes	Bolt Hole Diameter	Diameter of Circle of Holes	Filllet
	in mm	in mm	in mm	in mm	in mm	in mm	in mm		in mm	in mm	in mm
Class 400											
26	33.50 850.90	3.50 88.90	3.50 88.90	5.88 149.35	26.00 660.40	27.12 688.85	28.00 711.20	28	1.50 38.10	30.75 781.05	0.44 11.18
28	36.00 914.40	3.75 95.25	3.75 95.25	6.25 158.90	28.00 711.20	29.12 739.65	30.00 762.00	24	1.62 41.15	33.00 838.20	0.50 12.70
30	38.25 971.55	4.00 101.60	4.00 101.60	6.69 169.93	30.00 762.00	31.25 793.75	32.25 825.00	28	1.62 41.15	35.25 895.35	0.50 12.70
32	40.75 1035.1	4.25 107.95	4.25 107.95	7.06 179.32	32.00 812.80	33.25 844.55	34.38 873.25	28	1.75 44.45	37.50 952.50	0.50 12.70
34	42.75 1085.9	4.38 111.25	4.38 111.25	7.38 187.45	34.00 863.60	35.38 898.65	36.50 927.10	32	1.75 44.45	39.50 1003.3	0.56 14.22
36	45.50 1155.7	4.69 119.13	4.69 119.13	7.88 200.15	36.00 914.40	37.50 952.50	38.62 980.95	28	1.88 47.75	42.00 1066.8	0.56 14.22
Class 600											
26	35.00 889.00	4.38 111.25	4.38 111.25	7.12 180.85	26.00 660.40	27.50 698.50	28.62 726.95	28	1.75 44.45	31.75 806.45	0.50 12.70
28	37.50 952.50	4.56 115.82	4.56 115.82	7.50 190.50	28.00 711.20	29.62 752.35	30.88 784.35	28	1.88 47.75	34.00 863.60	0.50 12.70
30	40.25 1022.4	4.94 125.48	5.00 127.00	8.06 204.72	30.00 762.00	31.75 806.45	33.12 841.25	28	2.00 50.80	36.50 927.10	0.50 12.70
32	42.75 1085.9	5.12 130.05	5.31 134.87	8.50 215.90	32.00 812.80	33.88 860.55	35.25 895.35	28	2.12 53.85	38.75 984.25	0.50 12.70
34	45.75 1162.1	5.56 141.22	5.68 144.27	9.19 233.43	34.00 863.60	36.00 914.40	37.50 952.50	24	2.38 60.45	41.50 1054.1	0.56 14.22
36	47.75 1212.9	5.75 146.05	5.94 150.88	9.56 242.82	36.00 914.40	38.12 968.25	39.75 1009.7	28	2.38 60.45	43.50 1104.9	0.56 14.22
Class 900											
26	40.25 1022.4	5.31 134.87	6.06 153.92	10.19 258.83	26.00 660.40	29.25 742.95	30.00 762.00	20	2.62 66.55	35.50 901.70	0.44 11.18
28	43.50 1104.9	5.81 147.57	6.56 166.62	10.88 276.35	28.00 711.20	31.38 797.05	32.25 819.15	20	2.88 73.15	38.25 971.55	0.50 12.70
30	46.50 1181.1	6.12 155.45	6.93 176.02	11.38 289.05	30.00 762.00	33.50 850.90	34.50 876.30	20	3.12 79.25	40.75 1035.1	0.50 12.70
32	48.75 1238.3	6.31 160.27	7.31 185.67	11.94 303.28	32.00 812.80	35.75 908.05	36.50 927.10	20	3.12 79.25	43.00 1092.2	0.50 12.70
34	51.75 1314.5	6.75 171.45	7.68 195.07	12.56 319.02	34.00 863.60	37.88 962.15	39.00 990.60	20	3.38 85.85	45.50 1155.7	0.56 14.22
36	53.00 1346.2	6.81 172.97	7.94 201.68	12.81 325.37	36.00 914.40	40.00 1016.0	40.50 1028.7	24	3.12 79.25	47.25 1200.2	0.56 14.22

Notes

- ASME B16.47 Series B flanges are API 605 flanges. API 605 has been cancelled.
- Refer to ASME B16.47 Series A dimensions for sizes NPS 38 and larger (see pages 8-48 to 8-50).
- Dimension B is to be specified by the purchaser. It corresponds to the pipe inside diameter.
- WNF = Weld Neck Flange.
- Flat face flanges may be provided at full thickness, C + raised face, or with raised face removed (the latter is nonstandard).
- The large end of the hub may be straight or tapered.
- For ring joint facings see page 8-6. For weld end bevel see page 8-5. For tolerances see page 8-4.

BS 3293 : 1960

British Standard BS 3293 : 1960 - Carbon Steel Pipe Flanges (over 24 inches nominal size) for the Petroleum Industry, covers Class 150 lb to 600 lb weld neck and slip on flanges.

Dimensions and Tolerances

Tolerances on flange dimensions (BS 3293 : 1960)

Dimension	Tolerance		
	in	mm	
Weld Neck and Slip On Flanges (pages 8-56 to 8-59)	G (raised face diameter)	$\pm 1/64$	± 0.40
	C (flange thickness)	$+3/16, -0$	$+4.76, -0$
	D (overall length)	$\pm 1/8$	± 3.18
	E (outside diameter at welding end of weld neck hub)	$+5/32, -1/32$	$+3.97, -0.79$
	B (inside diameter of weld neck flange)	$+1/8, -1/16$	$+3.18, -1.59$
Ring Joint Facing on Weld Neck and Slip On Flanges (see below)	B (inside diameter of slip on flange)	$+1/16, -0$	$+1.59, -0$
	L (depth of groove)	$+1/64, -0$	$+0.40, -0$
	M (width of groove)	± 0.008	± 0.20
	K (pitch diameter of groove)	± 0.005	± 0.13

Ring Joint Facings - BS 3293

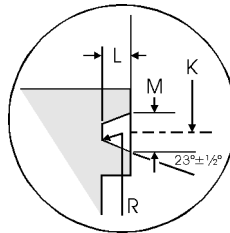
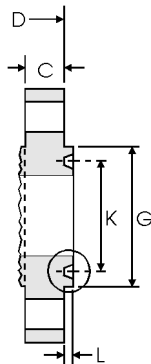

Note

- Values for minimum flange thickness, C, and overall length, D, are detailed in the flange tables.
- For ring joint tolerances see above.
- R = 1/16 in (0.40 mm) max, corner radius at bottom of groove.

Ring joint facing dimensions - BS 3293

Class (lb)				Groove/Ring Number	Raised Face	Groove			Weight		
150	300	400	600		G	K	L	M	kg/piece		
Nominal Pipe Size (NPS)					Face Diameter min	Pitch Diameter	Depth	Width	Class 300 lb	Class 400 lb	Class 600 lb
					in mm	in mm	in mm	in mm	WNF Slip on	WNF Slip on	WNF Slip on
	26	26	26	R93	31 ⁷ / ₈ 809.6	29 ¹ / ₂ 749.3	1 ¹ / ₂ 12.7	25 ⁵ / ₃₂ 19.8	298 270	349 304	446 417
	28	28	28	R94	33 ⁷ / ₈ 860.4	31 ¹ / ₂ 800.1	1 ¹ / ₂ 12.7	25 ⁵ / ₃₂ 19.8	360 333	409 364	518 482
	30	30	30	R95	36 ¹ / ₈ 917.6	33 ³ / ₄ 857.2	1 ¹ / ₂ 12.7	25 ⁵ / ₃₂ 19.8	412 376	465 419	570 537
	32	32	32	R96	38 ³ / ₄ 984.2	36 914.4	9 ⁹ / ₁₆ 14.3	29 ⁵ / ₃₂ 23.0	465 425	539 482	697 622
	34	34	34	R97	40 ³ / ₄ 1035.0	38 965.2	9 ⁹ / ₁₆ 14.3	29 ⁵ / ₃₂ 23.0	536 492	608 540	735 670
	36	36	36	R98	43 1092.2	40 ¹ / ₄ 1022.3	9 ⁹ / ₁₆ 14.3	29 ⁵ / ₃₂ 23.0	595 548	689 621	800 764

Note

- Weights are based on manufacturer's data and are approximate.

Weld Neck and Slip On Flanges - BS 3293

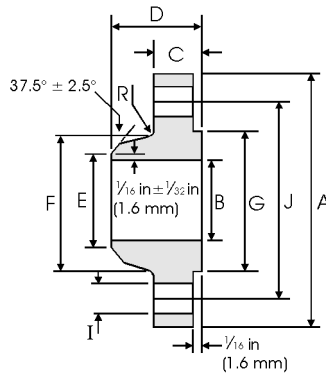

Weld Neck

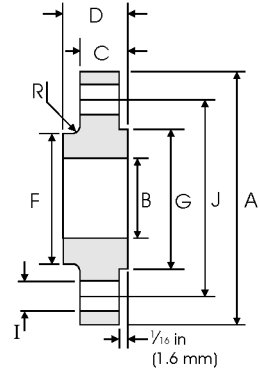

Slip On

Class 150 lb

Pipe Nominal Pipe Size	Flange Data				Hub Data		Raised Face	Drilling Data			Radius	Weight	
	A	B	C	D		E	F	G	H	I	J	R	
	Overall Diameter	Slip on Inside Diameter	Flange Thickness	WNF Overall Length	Slip on Overall Length	WNF Diameter at Weld Bevel	WNF / Slip on Hub Diameter	Face Diameter	Number of Holes	Bolt Hole Diam.	Diameter of Circle of Holes	Fillet	kg/ piece
in mm	in mm	in mm	in mm	in mm	in mm	in mm	in mm	in mm		in mm	in mm	in mm	WNF Slip On
26	34 ¹ / ₄ 869.9	26 ¹ / ₄ 666.7	2 50.8	5 127.0	3 ³ / ₈ 85.7	26 660.4	28 ¹ / ₂ 723.9	29 ¹ / ₄ 742.9	24	1 ³ / ₈ 34.9	31 ³ / ₄ 806.4	1 ¹ / ₄ 6.35	118 107
28	36 ¹ / ₂ 927.1	28 ¹ / ₄ 717.6	2 ¹ / ₁₆ 52.4	5 ¹ / ₁₆ 128.6	3 ⁷ / ₁₆ 87.3	28 711.2	30 ³ / ₄ 781.0	31 ¹ / ₄ 793.7	28	1 ³ / ₈ 34.9	34 863.6	1 ¹ / ₄ 6.35	134 122
30	38 ³ / ₄ 984.2	30 ¹ / ₄ 768.3	2 ¹ / ₈ 54.0	5 ¹ / ₈ 130.2	3 ¹ / ₂ 88.9	30 762.0	32 ³ / ₄ 831.8	33 ³ / ₄ 857.2	28	1 ³ / ₈ 34.9	36 914.4	1 ¹ / ₄ 6.35	153 138
32	41 ³ / ₄ 1060.4	32 ¹ / ₄ 819.1	2 ¹ / ₄ 57.1	5 ¹ / ₄ 133.3	3 ⁵ / ₈ 92.1	32 812.8	35 889.0	35 ³ / ₄ 908.0	28	1 ⁵ / ₈ 41.3	38 ¹ / ₂ 977.9	5 ¹ / ₁₆ 7.94	190 170
34	43 ³ / ₄ 1111.2	34 ¹ / ₄ 869.9	2 ⁵ / ₁₆ 58.7	5 ⁵ / ₁₆ 134.9	3 ¹¹ / ₁₆ 93.7	34 863.6	37 939.8	37 ³ / ₄ 958.8	32	1 ⁵ / ₈ 41.3	40 ¹ / ₂ 1028.7	5 ¹ / ₁₆ 7.94	212 184
36	46 1168.4	36 ¹ / ₄ 920.7	2 ³ / ₈ 60.3	5 ³ / ₈ 136.5	3 ³ / ₄ 95.2	36 914.4	39 ¹ / ₄ 996.9	40 ¹ / ₄ 1022.3	32	1 ⁵ / ₈ 41.3	42 ³ / ₄ 1085.8	5 ¹ / ₁₆ 7.94	242 211
38	48 ³ / ₄ 1238.2	38 ¹ / ₄ 971.5	2 ³ / ₈ 60.3	5 ³ / ₈ 136.5	3 ³ / ₄ 95.2	38 965.2	41 ³ / ₄ 1060.4	42 ¹ / ₄ 1073.1	32	1 ⁵ / ₈ 41.3	45 ¹ / ₄ 1149.3	3 ⁸ / ₁₆ 9.53	284 249
40	50 ³ / ₄ 1289.0	40 ¹ / ₄ 1022.3	2 ¹ / ₂ 63.5	5 ¹ / ₂ 139.7	3 ⁷ / ₈ 98.4	40 1016.0	43 ³ / ₄ 1111.2	44 ¹ / ₄ 1123.9	36	1 ⁵ / ₈ 41.3	47 ¹ / ₄ 1200.1	3 ⁸ / ₁₆ 9.53	311 272
42	53 1346.2	42 ¹ / ₄ 1073.2	2 ⁵ / ₈ 66.7	5 ⁵ / ₈ 142.9	4 101.6	42 1066.8	46 1168.4	47 1193.8	36	1 ⁵ / ₈ 41.3	49 ¹ / ₂ 1257.3	3 ⁸ / ₁₆ 9.53	358 313
44	55 ¹ / ₄ 1403.3	44 ¹ / ₄ 1123.9	2 ⁵ / ₈ 66.7	5 ⁵ / ₈ 142.9	4 101.6	44 1117.6	48 1219.2	49 1244.6	40	1 ⁵ / ₈ 41.3	51 ³ / ₄ 1314.4	7 ¹ / ₁₆ 11.11	376 331
46	57 ¹ / ₄ 1454.2	46 ¹ / ₄ 1174.7	2 ¹¹ / ₁₆ 68.3	5 ¹¹ / ₁₆ 144.5	4 ¹ / ₁₆ 103.2	46 1168.4	50 1270.0	51 1295.4	40	1 ⁵ / ₈ 41.3	53 ³ / ₄ 1365.2	7 ¹ / ₁₆ 11.11	399 349
48	59 ¹ / ₂ 1511.1	48 ¹ / ₄ 1225.5	2 ³ / ₄ 69.9	5 ³ / ₄ 146.1	4 ¹ / ₈ 104.8	48 1219.2	52 ¹ / ₄ 1327.2	53 ¹ / ₂ 1358.9	44	1 ⁵ / ₈ 41.3	56 1422.4	7 ¹ / ₁₆ 11.11	440 381

Notes

- For weld neck flanges, dimension B is to be specified by the purchaser. It corresponds to the pipe inside diameter.
- For slip on flanges, the hub may be cylindrical or have a draft of $\leq 7^\circ$ on the outside surface.
- WNF = Weld Neck Flange.
- Weights are based on manufacturer's data and are approximate.
- For ring joint facings see page 8-55.
- For tolerances see page 8-55.

Weld Neck and Slip On Flanges - BS 3293

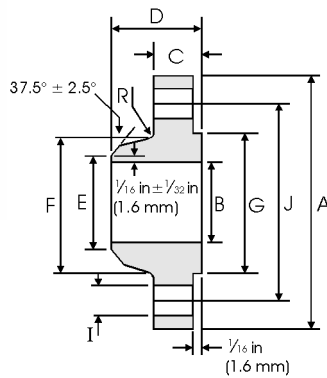

Weld Neck

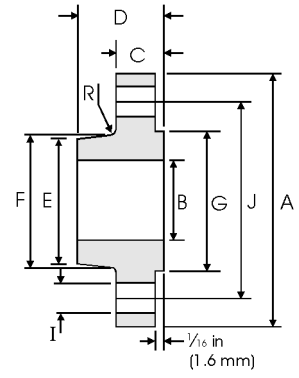

Slip On

Class 300 lb

Pipe	Flange Data				Hub Data			Raised Face	Drilling Data			Radius	Weight
	A	B	C	D	E		F	G	H	I	J	R	
	Overall Diameter	Slip on Inside Diameter	Flange Thickness	WNF / Slip on Overall Length	WNF Diam. at Weld Bevel	Slip on Hub Diam. at Small End	Hub Diameter	Face Diameter	Number of Holes	Bolt Hole Diam.	Diameter of Circle of Holes	Fillet	kg/ piece
in mm	in mm	in mm	in mm	in mm	in mm	in mm	in mm	in mm		in mm	in mm	in mm	WNF Slip On
26	38 ¹ / ₄ 971.5	26 ¹ / ₄ 666.7	3 ¹ / ₈ 79.4	7 ¹ / ₄ 184.1	26 ¹ / ₄ 666.7	27 ¹ / ₁₆ 687.4	28 ³ / ₈ 720.7	29 ¹ / ₂ 749.3	28	1 ³ / ₄ 44.4	34 ¹ / ₂ 876.3	³ / ₈ 9.53	279 251
28	40 ³ / ₄ 1035.0	28 ¹ / ₄ 717.6	3 ³ / ₈ 85.7	7 ³ / ₄ 196.8	28 ¹ / ₄ 717.5	29 ¹ / ₈ 739.7	30 ¹ / ₂ 774.7	31 ¹ / ₂ 800.1	28	1 ³ / ₄ 44.4	37 939.8	⁷ / ₁₆ 11.11	340 313
30	43 1092.2	30 ¹ / ₄ 768.3	3 ⁵ / ₈ 92.1	8 ¹ / ₄ 209.5	30 ¹ / ₄ 768.3	31 ³ / ₁₆ 792.2	32 ⁹ / ₁₆ 827.2	33 ³ / ₄ 857.2	28	1 ⁷ / ₈ 47.6	39 ¹ / ₄ 996.9	⁷ / ₁₆ 11.11	390 354
32	45 ¹ / ₄ 1149.3	32 ¹ / ₄ 819.1	3 ⁷ / ₈ 98.4	8 ³ / ₄ 222.2	32 ¹ / ₄ 819.1	33 ¹ / ₄ 844.6	34 ¹¹ / ₁₆ 881.1	36 914.4	28	2 50.8	41 ¹ / ₂ 1054.1	⁷ / ₁₆ 11.11	435 395
34	47 ¹ / ₂ 1206.5	34 ¹ / ₄ 869.9	4 101.6	9 ¹ / ₈ 231.8	34 ⁵ / ₁₆ 871.5	35 ⁵ / ₁₆ 896.9	36 ⁷ / ₈ 936.6	38 965.2	28	2 50.8	43 ¹ / ₂ 1104.9	¹ / ₂ 12.7	504 460
36	50 1270.0	36 ¹ / ₄ 920.7	4 ¹ / ₈ 104.8	9 ¹ / ₂ 241.3	36 ⁵ / ₁₆ 922.3	37 ³ / ₈ 949.3	39 990.6	40 ¹ / ₄ 1022.3	32	2 ¹ / ₈ 54.0	46 1168.4	¹ / ₂ 12.7	560 513

Notes

- For weld neck flanges, dimension B is to be specified by the purchaser. It corresponds to the pipe inside diameter.
- For slip on flanges, the hub may be cylindrical or have a draft of $\leq 7^\circ$ on the outside surface.
- WNF = Weld Neck Flange.
- Weights are based on manufacturer's data and are approximate.
- For ring joint facings see page 8-55.
- For tolerances see page 8-55.

Weld Neck and Slip On Flanges - BS 3293

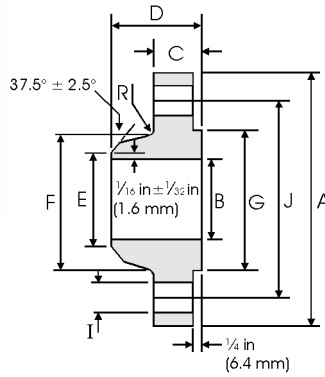
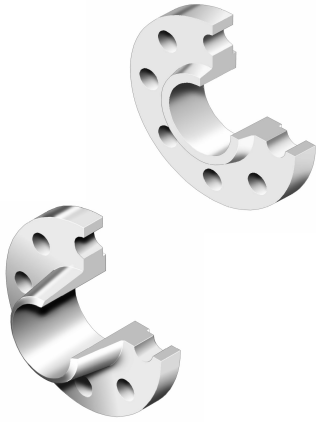

Weld Neck

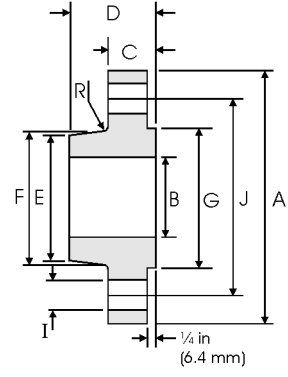

Slip On

Class 400 lb

Pipe Nominal Pipe Size	Flange Data				Hub Data			Raised Face	Drilling Data			Radius	Weight
	A	B	C	D	E	F	G	H	I	J	R		
	Overall Diameter	Slip on Inside Diameter	Flange Thickness	WNF / Slip on Overall Length	WNF Diam. at Weld Bevel	Slip on Hub Diam. at Small End	Hub Diameter	Face Diameter	Number of Holes	Bolt Hole Diam.	Diameter of Circle of Holes	Fillet	kg/ piece
in mm	in mm	in mm	in mm	in mm	in mm	in mm	in mm	in mm		in mm	in mm	in mm	WNF Slip On
26	38 ¹ / ₄ 971.5	26 ¹ / ₄ 666.7	3 ¹ / ₂ 88.9	7 ⁵ / ₈ 193.7	26 ⁵ / ₁₆ 668.3	27 ⁵ / ₁₆ 693.7	28 ⁵ / ₈ 727.1	29 ¹ / ₂ 749.3	28	1 ⁷ / ₈ 47.6	34 ¹ / ₂ 876.3	⁷ / ₁₆ 11.11	340 295
28	40 ³ / ₄ 1035.0	28 ¹ / ₄ 717.6	3 ³ / ₄ 95.2	8 ¹ / ₈ 206.4	28 ⁵ / ₁₆ 719.1	29 ³ / ₈ 746.1	30 ¹³ / ₁₆ 782.6	31 ¹ / ₂ 800.1	28	2 50.8	37 939.8	¹ / ₂ 12.7	399 354
30	43 1092.2	30 ¹ / ₄ 768.3	4 101.6	8 ⁵ / ₈ 219.1	30 ⁵ / ₁₆ 769.6	31 ¹ / ₂ 800.1	32 ¹⁵ / ₁₆ 836.6	33 ³ / ₄ 857.2	28	2 ¹ / ₈ 54.0	39 ¹ / ₄ 996.9	¹ / ₂ 12.7	454 408
32	45 ¹ / ₄ 1149.3	32 ¹ / ₄ 819.1	4 ¹ / ₄ 107.9	9 ¹ / ₈ 231.8	32 ³ / ₈ 822.3	33 ⁹ / ₁₆ 852.5	35 889.0	36 914.4	28	2 ¹ / ₈ 54.0	41 ¹ / ₂ 1054.1	¹ / ₂ 12.7	522 465
34	47 ¹ / ₂ 1206.5	34 ¹ / ₄ 869.9	4 ³ / ₈ 111.1	9 ¹ / ₂ 241.3	34 ³ / ₈ 873.1	35 ⁵ / ₈ 904.9	37 ³ / ₁₆ 944.6	38 965.2	28	2 ¹ / ₈ 54.0	43 ¹ / ₂ 1104.9	⁹ / ₁₆ 14.29	590 522
36	50 1270.0	36 ¹ / ₄ 920.8	4 ¹ / ₂ 114.3	9 ⁷ / ₈ 250.8	36 ⁷ / ₁₆ 925.5	37 ³ / ₄ 958.8	39 ⁷ / ₈ 1012.9	40 ¹ / ₄ 1022.3	32	2 ¹ / ₈ 54.0	46 1168.4	⁹ / ₁₆ 14.29	669 601

Notes

- For weld neck flanges, dimension B is to be specified by the purchaser. It corresponds to the pipe inside diameter.
- For slip on flanges, the hub may be cylindrical or have a draft of $\leq 7^\circ$ on the outside surface.
- WNF = Weld Neck Flange.
- Weights are based on manufacturer's data and are approximate.
- For ring joint facings see page 8-55.
- For tolerances see page 8-55.

Weld Neck and Slip On Flanges - BS 3293

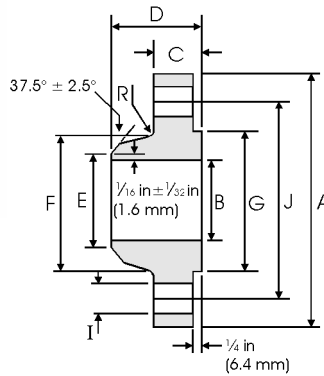

Weld Neck

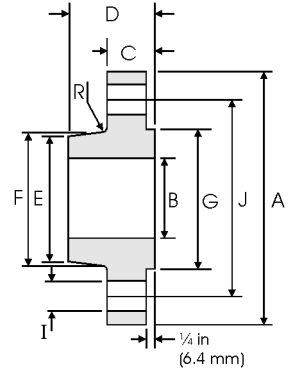

Slip On

Class 600 lb

Pipe	Flange Data				Hub Data			Raised Face	Drilling Data			Radius	Weight
Nominal Pipe Size	A	B	C	D	E		F	G	H	I	J	R	
	Overall Diameter	Slip on Inside Diameter	Flange Thickness	WNF / Slip on Overall Length	WNF Diam. at Weld Bevel	Slip on Hub Diam. at Small Lend	Hub Diameter	Face Diameter	Number of Holes	Bolt Hole Diam.	Diameter of Circle of Holes	Fillet	kg/ piece
	in mm	in mm	in mm	in mm	in mm	in mm	in mm	in mm		in mm	in mm	in mm	in mm
26	40 1016.0	26 ¹ / ₄ 666.7	4 ¹ / ₄ 107.9	8 ³ / ₄ 222.2	26 ⁷ / ₁₆ 671.52	27 ¹³ / ₁₆ 706.4	29 ⁷ / ₁₆ 747.7	29 ¹ / ₂ 749.3	28	2 50.8	36 914.4	9 ⁹ / ₁₆ 14.29	437 408
28	42 ¹ / ₄ 1073.1	28 ¹ / ₄ 717.6	4 ³ / ₈ 111.1	9 ¹ / ₄ 234.9	28 ¹ / ₂ 723.9	29 ¹⁵ / ₁₆ 760.4	31 ⁵ / ₈ 803.3	31 ¹ / ₂ 800.1	28	2 ¹ / ₈ 54.0	38 965.2	5 ⁵ / ₈ 15.88	508 472
30	44 ¹ / ₂ 1130.3	30 ¹ / ₄ 768.3	4 ¹ / ₂ 114.3	9 ³ / ₄ 247.6	30 ¹ / ₂ 774.7	32 ¹ / ₁₆ 814.4	33 ¹⁵ / ₁₆ 862.0	33 ³ / ₄ 857.2	28	2 ¹ / ₈ 54.0	40 ¹ / ₄ 1022.3	1 ¹¹ / ₁₆ 17.46	559 526
32	47 1193.8	32 ¹ / ₄ 819.1	4 ⁵ / ₈ 117.5	10 ¹ / ₄ 260.3	32 ¹ / ₂ 825.5	34 ³ / ₁₆ 868.4	36 ¹ / ₈ 917.6	36 914.4	28	2 ³ / ₈ 60.3	42 ¹ / ₂ 1079.5	1 ¹¹ / ₁₆ 17.46	680 605
34	49 1244.6	34 ¹ / ₄ 869.9	4 ³ / ₄ 120.6	10 ⁵ / ₈ 269.9	34 ⁹ / ₁₆ 877.9	36 ⁵ / ₁₆ 922.3	38 ⁵ / ₁₆ 973.1	38 965.2	28	2 ³ / ₈ 60.3	44 ¹ / ₂ 1130.3	3 ³ / ₄ 19.05	717 652
36	51 ³ / ₄ 1314.4	36 ¹ / ₄ 920.7	4 ⁷ / ₈ 123.8	11 ¹ / ₈ 282.6	36 ⁹ / ₁₆ 928.7	38 ⁷ / ₁₆ 976.3	40 ⁵ / ₈ 1031.9	40 ¹ / ₄ 1022.3	28	2 ⁵ / ₈ 66.7	47 1193.8	3 ³ / ₄ 19.05	780 744

Notes

- For weld neck flanges, dimension B is to be specified by the purchaser. It corresponds to the pipe inside diameter.
- For slip on flanges, the hub may be cylindrical or have a draft of $\leq 7^\circ$ on the outside surface.
- WNF = Weld Neck Flange.
- Weights are based on manufacturer's data and are approximate.
- For ring joint facings see page 8-55.
- For tolerances see page 8-55.

BS 4504 Circular Flanges - General

British Standard BS 4504 : Section 3.1 : 1989 - Circular Flanges for Pipes, Valves and Fittings (PN Designated), Specification for Steel Flanges. This covers flanges in nominal pressure ranges PN 2.5 to PN 40 and nominal sizes up to DN 4000 (see table below). BS 4504 substantially agrees with ISO 7005-1 : 1992 (E) Part 1 : Steel Flanges.

BS 4504 : 1969 is still commonly used. This older standard allows for manufacture from bar, whereas the latest standard specifies that forging or plate are to be used, which can be significantly more expensive. There are minor differences in dimensions between the two versions. The following tables are based on the later version.

Summary of flanges covered by BS 4504 : Section 3.1

Code No.	Description	PN Range	DN Range
101	Plate flange for welding (see page 8-65)	PN 2.5	DN 10 to DN 2000
		PN 6, 10, 16, 25, 40	DN 10 to DN 600
102 ¹	Loose plate flange with weld-on plate collar or for lapped pipe end (Weld-on plate collar = Code 132 ¹ Lapped pipe end = Code 133 ¹)	PN 6, 10, 16, 25, 40	DN 10 to DN 600
104 ¹	Loose plate flange with weld-neck collar (Weld-neck collar = Code 134 ¹)	PN 6, 10, 16, 25, 40	DN 10 to DN 600
105	Blank flange (see page 8-70)	PN 2.5, 6	DN 10 to DN 2000
		PN 10, 16	DN 10 to DN 1200
		PN 25, 40	DN 10 to DN 600
111	Weld-neck flange (see page 8-66)	PN 2.5, 6, 10, 16	DN 10 to DN 2000 ²
		PN 25	DN 10 to DN 1000
		PN 40	DN 10 to DN 600
112	Hubbed slip-on flange for welding (see page 8-68)	PN 6	DN 10 to DN 300
		PN 10, 16, 25, 40	DN 10 to DN 600
113	Hubbed threaded flange (see page 8-69)	PN 6, 10, 16, 25, 40	DN 10 to DN 150
121 ¹	Integral flange	PN 6, 10, 16, 25	DN 10 to DN 2000
		PN 40	DN 10 to DN 600

Notes

- Flanges > DN 2000, are not covered in this summary.
- Dimensions: Nominal sizes, DN followed by a numerical designation of size (a convenient round number for reference purposes), are used as defined in ISO 6708.
- Pressure Ratings: Nominal pressures, i.e. PN followed by a numerical designation of size (a convenient round number for reference purposes), are used as defined in ISO 7268.

1 Dimensions for these flanges are not covered in this summary.

2 The DN range for weld neck flanges extends to DN 4000 for PN 2.5, to DN 3600 for PN 6, and to DN 3000 for PN 10.

Designations/Marking

Marking. All flanges are marked with BS number, code number, PN, DN, material designation, manufacturers name or trade mark, cast number or melt identification, thread identification, An example follows:

BS 4504/111/B - PN 16 - DN 400 - B4 - XXX - 12345

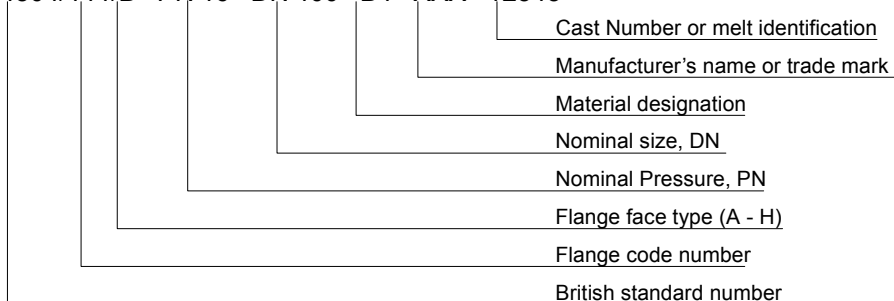

BS 4504 Circular Flanges - General

Dimensions and Tolerances

Dimension	Range	Tolerance	
		mm	
Flange Facings (see page 8-63)	Eccentricity of machined facing diameters	≤ DN 100 > DN 100	1.0 2.0
	a (type B facing height)	2 mm	+0, -1.0
		3 mm	+0, -2.0
		4 mm	+0, -3.0
		5 mm	+0, -4.0
		6 mm	+0, -5.0
	b (type C and E facing height)	All	+0.5, -0
	b (type G facing height)	All	+0, -0.5
	b (type H facing height, outer)	All	+0.2, -0
	c (type D and F facing height)	All	+0, -0.5
	d (type H facing height, inner)	All	+0.5, -0
B and E (facing diameters)	All	+0, -0.5	
C and D (facing diameters)	All	+0.5, -0	
Surface Finish	Facing types A, B, E and F	All, turning All, other than turning	Ra = 3.2 µm min 12.5 µm max Ra = 3.2 µm min 6.3 µm max
	Facing types C, D, G and H	All	Ra = 0.8 µm min 3.2 µm max
Flange Drilling Details (see page 8-64)	B (diameter of bolt circle)	Bolt sizes M10 to M24 Bolt sizes M27 to M45	±0.9 ±1.4
	Centre to centre of adjacent bolt holes	Bolt sizes M10 to M24 Bolt sizes M27 to M45	±0.45 ±0.7
All	A (outside diameter)	≤ DN 150	±2.0
		> DN 150 ≤ DN 500	±3.0
		> DN 500 ≤ DN 1200	±5.0
		> DN 1200 ≤ DN 1800	±7.0
		> DN 1800	±10.0
	C (flange thickness, machined on both faces)	≤ 18 mm thickness	±1.0
		> 18 mm < 50 mm thickness	±1.0
	C (flange thickness, machined on front face)	≤ 18 mm thickness	+2.0, -1.0
> 18 mm < 50 mm thickness		+4.0, -1.5	
> 50 mm thickness		+7.0, -2.0	
Weld Neck Flanges, Code 111 (see page 8-66)	B (outside diameter of hub at welding end)	≤ DN 125	+3.0, -0
		> DN 125 ≤ DN 1200	+4.5, -0
		> DN 1200	+6.0, -0
	F (hub diameter)	≤ DN 50	+0, -2.0
		> DN 50 ≤ DN 150	+0, -4.0
		> DN 150 ≤ DN 300	+0, -6.0
		> DN 300 ≤ DN 600	+0, -8.0
		> DN 600 ≤ DN 1200	+0, -10.0
D (length through hub)	≤ DN 80	±1.5	
	> DN 80 ≤ DN 250	±2.0	
	> DN 250	±3.0	
Slip on, Code 112 (see page 8-68) and Threaded, Code 113 (see page 8-69) Flanges	E (slip on flange hub diameter) B (threaded flange hub diameter)	≤ DN 50	+1.0, -0
		> DN 50 ≤ DN 150	+2.0, -0
		> DN 150 ≤ DN 300	+4.0, -0
		> DN 300 ≤ DN 600	+8.0, -0
		> DN 600 ≤ DN 1200	+12.0, -0
		> DN 1200 ≤ DN 1800	+16.0, -0
		> DN 1800	+20.0, -0
	B (slip on bore diameter)	≤ DN 100	+0.5, -0
		> DN 100 ≤ DN 400	+1.0, .0
		> DN 400 ≤ DN 600	+1.5, .0
D (length through hub)	> DN 600	+3.0, -0	
Blank Flanges, Code 105 (see page 8-70)	B (flange thickness)	Same as Weld Neck D	
	C (unmachined centre portion)	Same as C for all other flanges Maximum specified	

BS 4504 Circular Flanges - General

Weld Neck Flange - Welding Ends

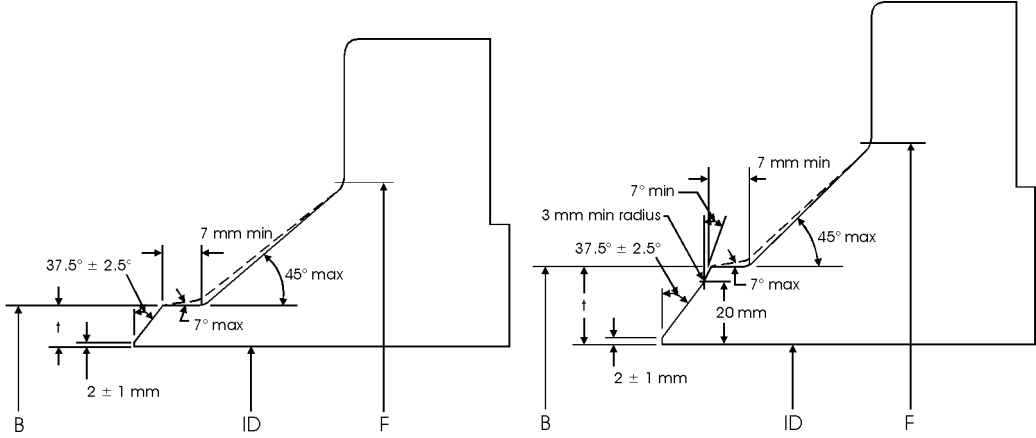

Welding end for Wall Thickness (t) from 5 mm to 22.2 mm

Welding end for Wall Thickness (t) > 22.2 mm

Flange Facings - BS 4504

BS 4504 flange facing types A to H are defined below. The dimensions vary with pipe size (DN) and pressure rating (PN) as detailed in the following table.

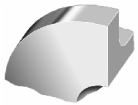

Type A
Flat face

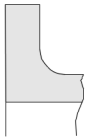

Type B
Raised face

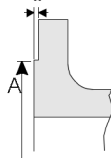

Type C
Tongue face

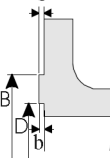

Type D
Groove face

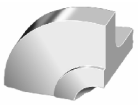
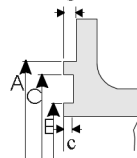

Type E
Spigot

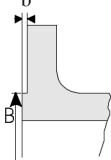

Type F
Recess

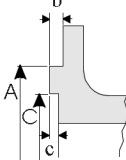

Type G
'O' Ring recess

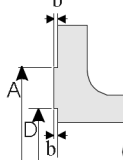

Type H
'O' Ring groove

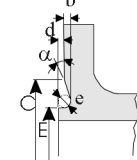

BS 4504 Circular Flanges - General

Flange facing dimensions (BS 4504)

DN	A mm						Face Dimensions									
	PN 2.5	PN 6	PN 10	PN 16	PN 25	PN 40	B	C	D	E	a	b	c	d	α	e
	mm	mm	mm	mm	mm	mm	mm	mm	mm	mm	mm	mm	mm	mm	mm	mm
10	35	35	40	40	40	40	34	35	24	23	2	4	3	2	-	5
15	40	40	45	45	45	45	39	40	29	28	2	4	3	2	-	5
20	50	50	58	58	58	58	50	51	36	35	2	4	3	2	41°16'	5
25	60	60	68	68	68	68	57	58	43	42	2	4	3	2	41°16'	5
32	70	70	78	78	78	78	65	66	51	50	2	4	3	2	41°16'	5
40	80	80	88	88	88	88	75	76	61	60	3	4	3	2	41°16'	5
50	90	90	102	102	102	102	87	88	73	72	3	4	3	2	41°16'	5
65	110	110	122	122	122	122	109	110	95	94	3	4	3	2	41°16'	5
80	128	128	138	138	138	138	120	121	106	105	3	4	3	2	41°16'	5
100	148	148	158	158	162	162	149	150	129	128	3	4.5	3.5	2.5	32°15'	6
125	178	178	188	188	188	188	175	176	155	154	3	4.5	3.5	2.5	32°15'	6
150	202	202	212	212	218	218	203	204	183	182	3	4.5	3.5	2.5	32°15'	6
200	258	258	268	268	278	285	259	260	239	238	3	4.5	3.5	2.5	32°15'	6
250	312	312	320	320	335	345	312	313	292	291	3	4.5	3.5	2.5	32°15'	6
300	365	365	370	378	395	410	363	364	343	342	4	4.5	3.5	2.5	32°15'	6
350	415	415	430	438	450	465	421	422	395	394	4	5	4	3	27°24'	7
400	465	465	482	490	505	535	473	474	447	446	4	5	4	3	27°24'	7
450	520	520	532	550	555	560	523	524	497	496	4	5	4	3	27°24'	7
500	570	570	585	610	615	615	575	576	549	548	4	5	4	3	27°24'	7
600	670	670	685	725	720	735	675	676	649	648	5	5	4	3	27°24'	7
700	775	775	800	795	820	-	777	778	751	750	5	5	4	3	27°24'	7
800	880	880	905	900	930	-	882	883	856	855	5	5	4	3	27°24'	7
900	980	980	1005	1000	1030	-	987	988	961	960	5	5	4	3	27°24'	7
1000	1080	1080	1110	1115	1140	-	1092	1094	1062	1060	5	6	5	4	28°39'	8
1200	1280	1295	1330	1330	1350	-	1292	1294	1262	1260	5	6	5	4	28°39'	8
1400	1480	1510	1535	1530	1560	-	1492	1494	1462	1460	5	6	5	4	28°39'	8
1600	1690	1710	1760	1750	1780	-	1692	1694	1662	1660	5	6	5	4	28°39'	8
1800	1890	1920	1960	1950	1985	-	1982	1894	1862	1860	5	6	5	4	28°39'	8
2000	2090	2125	2170	2150	2210	-	2092	2094	2062	2060	5	6	5	4	28°39'	8

Manufacture

- **Materials.** Flange codes 111 112 and 113 are manufactured from a forging or steel casting. Stainless steel forgings conforming to ASTM A 182, have an additional requirement for grade F304L and F316L that carbon content (by ladle analysis) shall be 0.030% max. Forgings to BS 1503 and comparable ASTM standard grades specified in BS 4504 are as listed in the following table.

BS and ASTM forging grades in BS 4504

BS 1503 Grade	ASTM A 182 Grade
304S11	F304L
304S31	F304
304S51	F304H
347S31	F347
347S51	F347H
321S31	F321
321S51	F321H
316S11	F316L
316S31	F316
316S51	F316H
310S31	F310

Flange Drilling Details - BS 4504

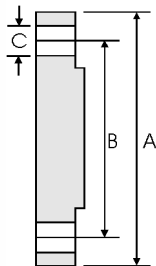
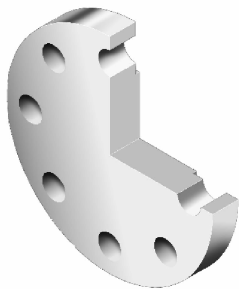

DN	PN	A	B	C	Bolt Holes	
		mm	mm	mm	No.	Bolt size
10	2.5 & 6	75	50	11	4	M10
	10,16	90	60	14	4	M12
15	2.5 & 6	80	55	11	4	M10
	10 & 16	95	65	14	4	M12
20	2.5 & 40	95	65	14	4	M12
	2.5 & 6	90	65	11	4	M10
25	10 & 16	105	75	14	4	M12
	25 & 40	105	75	14	4	M12
32	2.5 & 6	100	75	11	4	M10
	10 & 16	115	85	14	4	M12
40	2.5 & 40	115	85	14	4	M12
	2.5 & 6	120	90	14	4	M12
50	10 & 16	140	100	18	4	M16
	25 & 40	140	100	18	4	M16
65	2.5 & 6	130	100	14	4	M12
	10 & 16	150	110	18	4	M16
80	25 & 40	150	110	18	4	M16
	2.5 & 6	140	110	14	4	M12
100	10 & 16	165	125	18	4	M16
	25 & 40	165	125	18	4	M16
125	2.5 & 6	160	130	14	4	M12
	10 & 16	185	145	18	4/8	M16
150	25 & 40	185	145	18	8	M16
	2.5 & 6	190	150	18	4	M16
200	10 & 16	200	160	18	8	M16
	25 & 40	200	160	18	8	M16
250	2.5 & 6	210	170	18	4	M16
	10 & 16	220	180	18	8	M16
300	25 & 40	235	190	22	8	M20
	2.5 & 6	240	200	18	8	M16
350	10 & 16	250	210	18	8	M16
	25 & 40	270	220	26	8	M24
400	2.5 & 6	265	225	18	8	M16
	10 & 16	285	240	22	8	M20
450	25 & 40	300	250	26	8	M24
	2.5 & 6	320	280	18	8	M16
500	10 & 16	340	295	22	8/12	M20
	25	360	310	26	12	M24
550	40	375	320	30	12	M27
	2.5 & 6	375	335	18	12	M16
600	10	395	350	22	12	M20
	16	405	355	26	12	M24
650	25	425	370	30	12	M27
	40	450	385	33	12	M30
700	2.5 & 6	440	395	22	12	M20
	10	445	400	22	12	M20
750	16	460	410	26	12	M24
	25	485	430	30	16	M27
800	40	515	450	33	16	M30

DN	PN	A	B	C	Bolt Holes	
		mm	mm	mm	No.	Bolt size
350	2.5 & 6	490	445	22	12	M20
	10	505	460	22	16	M20
	16	520	470	26	16	M24
	25	555	490	33	16	M30
	40	580	510	36	16	M33
400	2.5 & 6	540	495	22	16	M20
	10	565	515	26	16	M24
	16	580	525	30	16	M27
	25	620	550	36	16	M33
	40	660	585	39	16	M36
450	2.5 & 6	595	550	22	16	M20
	10	615	565	26	20	M24
	16	640	585	30	20	M27
	25	670	600	36	20	M33
	40	685	610	39	20	M36
500	2.5 & 6	645	610	22	20	M20
	10	670	620	26	20	M24
	16	715	650	33	20	M30
	25	730	660	36	20	M33
	40	755	670	42	20	M39
600	2.5 & 6	755	705	26	20	M24
	10	780	725	30	20	M27
	16	840	770	36	20	M33
	25	845	770	39	20	M36
	40	890	795	48	20	M45
700	2.5 & 6	860	810	26	24	M24
	10	895	840	30	24	M27
	16	910	840	36	24	M33
	25	960	875	42	24	M39
	800	2.5 & 6	975	920	30	24
10		1015	950	33	24	M30
16		1025	950	39	24	M36
25		1085	990	48	24	M45
900		2.5 & 6	1075	1020	30	24
	10	1115	1050	33	28	M30
	16	1125	1050	39	28	M36
	25	1185	1090	48	28	M45
	1000	2.5 & 6	1175	1120	30	28
10		1230	1160	36	28	M33
16		1255	1170	42	28	M39
25		1320	1210	56	28	M52
1200		2.5	1375	1320	30	32
	6	1405	1340	33	32	M30
	10	1455	1380	39	32	M36
	16	1485	1390	48	32	M45
	25	1530	1420	56	32	M52
1400	2.5	1575	1520	30	36	M27
	6	1630	1560	36	36	M33
	10	1675	1590	42	36	M39
	16	1685	1590	48	36	M45
	25	1755	1640	62	36	M56
1600	2.5	1790	1730	30	40	M27
	6	1830	1760	36	40	M33
	10	1915	1820	48	40	M45
	16	1930	1820	56	40	M52
	25	1975	1860	62	40	M56
1800	2.5	1990	1930	30	44	M27
	6	2045	1970	39	44	M36
	10	2115	2020	48	44	M45
	16	2130	2020	56	44	M52
	25	2185	2070	70	44	M64
2000	2.5	2190	2130	30	48	M27
	6	2265	2180	42	48	M39
	10	2325	2230	48	48	M45
	16	2345	2230	62	48	M56
	25	2425	2300	70	48	M64

Plate Flanges (Code 101) - BS 4504

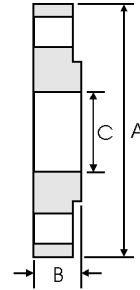
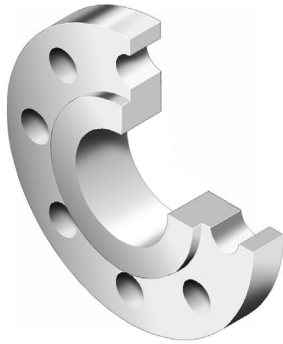

DN	PN	A mm	B mm	C mm
10	2.5 & 6	75	12	18.0
	10 & 16	90	14	
	25 & 40	90	14	
15	2.5 & 6	80	12	22
	10 & 16	95	14	
	25 & 40	95	14	
20	2.5 & 6	90	14	27.5
	10 & 16	105	16	
	25 & 40	105	16	
25	2.5 & 6	100	14	34.5
	10 & 16	115	16	
	25 & 40	115	16	
32	2.5 & 6	120	16	43.5
	10 & 16	140	18	
	25 & 40	140	18	
40	2.5 & 6	130	16	49.5
	10 & 16	150	18	
	25 & 40	150	18	
50	2.5 & 6	140	16	61.5
	10 & 16	165	20	
	25 & 40	165	20	
65	2.5 & 6	160	16	77.5
	10 & 16	185	20	
	25 & 40	185	22	
80	2.5 & 6	190	18	90.5
	10 & 16	200	20	
	25 & 40	200	24	
100	2.5 & 6	210	18	116.0
	10 & 16	220	22	
	25 & 40	235	26	
125	2.5 & 6	240	20	141.5
	10 & 16	250	22	
	25 & 40	270	28	
150	2.5 & 6	265	20	170.5
	10 & 16	285	24	
	25 & 40	300	30	
200	2.5 & 6	320	22	221.5
	10 & 16	340	24	
	25	360	32	
	40	375	36	
250	2.5 & 6	375	24	276.5
	10	395	26	
	16	405	29	
	25	425	35	
	40	450	42	

DN	PN	A mm	B mm	C mm
300	2.5 & 6	440	24	327.5
	10	445	26	
	16	460	32	
	25	485	38	
350	40	515	48	359.5
	2.5 & 6	490	26	
	10	505	28	
	16	520	35	
400	25	555	42	359.0
	40	580	54	
	2.5 & 6	540	28	
	10	565	32	
450	16	580	38	411.0
	25	620	46	
	40	660	60	
	2.5 & 6	595	30	
500	10	615	36	462.0
	16	640	42	
	25	670	50	
	40	685	66	
550	2.5 & 6	645	30	513.5
	10	670	38	
	16	715	46	
	25	730	56	
600	40	755	72	616.5
	2.5 & 6	755	32	
	10	780	42	
	16	840	52	
700	25	845	68	To be specified by purchaser
	40	890	84	
	2.5	860	36	
	800	2.5	975	
900	2.5	1075	40	
	1000	2.5	1175	42
1200	2.5	1375	44	
	1400	2.5	1575	48
1600	2.5	1790	51	
	1800	2.5	1990	54
2000	2.5	2190	58	

Notes

- Dimension B is the flange thickness with or without a raised face.
- For drilling details see page 8-64.
- For tolerances see page 8-61.
- For facing types and dimensions see page 8-62.

Weld Neck Flanges (Code 111) - BS 4504

DN	PN	A	B	C	D	E	F	G	H
		mm	mm	mm	mm	mm	mm	mm	mm
500	2.5,6	645	508	24	68	15	538	12	7.1
	10	670		28	75	16	540		7.1
	16	715		34	90		546		8
	25	730		44	125	20	558		10
	40	755		52	140		562		14.2
600	2.5,6	755	610	24	70	16	640	12	7.1
	10	780		28	80	18	640		7.1
	16	840		36	95		650		8.8
	25	845		46	125	20	660		11
	40	890		60	150		666		16
700	2.5	860	711	24	70	16	740	12	.1
	6	860		24	70		740		7.1
	10	895		30	80	18	746		8
	16	910		36	100		750		8.8
	25	960		46	125	20	760		12.5
800	2.5	975	813	26	70	16	842	12	.1
	6	975		24	70		842		7.1
	10	1015		32	90	18	848		8
	16	1025		38	105	20	848		10
	25	1085		50	135	22	864		14.2
900	2.5	1075	914	26	70	16	942	12	.1
	6	1075		26	70		942		7.1
	10	1115		34	95	20	948		10
	16	1125		40	110		948		10
	25	1185		54	145	24	968		16
1000	2.5	1175	1016	26	70	16	1045	12	.1
	6	1175		26	70		1045		7.1
	10	1230		34	95	20	1050		10
	16	1255		42	120	22	1056		10
	25	1320		58	155	24	1070		17.5
1200	2.5	1375	1220	26	70	16	1245	16	.1
	6	1405		28	90	20	1248		8
	10	1455		38	115	25	1256		12
	16	1485		48	130	30	1260		12.5
	25	1575		26	70	16	1445		16
1400	6	1630	1420	32	90	20	1452	12	8
	10	1675		42	120	25	1460		12
	16	1685		52	145	30	1465		14.2
	25	1790		26	80	20	1645		16
1600	6	1830	1620	34	90	20	1655	12	9
	10	1915		46	130	25	1666		14
	16	1930		58	160	35	1668		16
	25	1990		26	80	20	1845		16
1800	6	2045	1820	36	100		1855	15	10
	10	2115		50	140	30	1866		15
	16	2130		62	170	35	1870		17.5
	25	2190		26	80	22	2045		16
2000	6	2265	2020	38	110	25	2058	15	11
	10	2325		54	150	30	2070		16
	16	2345		66	190	40	2072		20

Notes

- For drilling details see page 8-64.
- For tolerances see page 8-61.
- For facing types and dimensions see page 8-62.
- 1 To be specified by the purchaser.

Slip On Flanges (Code 112) - BS 4504

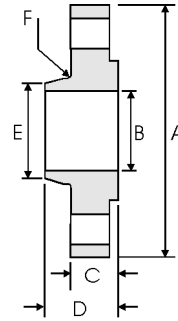

DN	PN	A	B	C	D	E	F
		mm	mm	mm	mm	mm	mm
10	6	75	18.0	12	20	25	3
	10 & 16	90		14	20	30	
	25 & 40	90		16	22	30	
15	6	80	22	12	20	30	3
	10 & 16	95		14	20	35	
	25 & 40	95		16	22	35	
20	6	90	27.5	14	24	40	4
	10 & 16	105		16	24	45	
	25 & 40	105		18	26	45	
25	6	100	34.5	14	24	50	4
	10 & 16	115		16	24	52	
	25 & 40	115		18	28	52	
32	6	120	43.5	14	26	60	5
	10 & 16	140		16	26	60	
	25 & 40	140		18	30	60	
40	6	130	49.5	14	26	70	5
	10 & 16	150		16	26	70	
	25 & 40	150		18	32	70	
50	6	140	61.5	14	28	80	5
	10 & 16	165		18	28	84	
	25 & 40	165		20	34	84	
65	6	160	77.5	14	32	100	6
	10 & 16	185		18	32	104	
	25 & 40	185		22	38	104	
80	6	190	90.5	16	34	110	6
	10 & 16	200		20	34	118	
	25 & 40	200		24	40	118	
100	6	210	116.0	16	40	130	6
	10 & 16	220		20	40	140	
	25 & 40	235		24	44	145	
125	6	240	141.5	18	44	160	6
	10 & 16	250		22	44	168	
	25 & 40	270		26	48	170	
150	6	265	170.5	18	44	185	8
	10 & 16	285		22	44	195	
	25 & 40	300		28	75	190	

DN	PN	A	B	C	D	E	F
		mm	mm	mm	mm	mm	mm
200	6	320	221.5	20	44	240	8
	10 & 16	340		24	44	246	
	25	360		30	52	256	
	40	375		34	52	260	
250	6	375	276.5	22	44	295	10
	10	395		26	46	298	
	25	425		26	46	298	
	40	450		32	60	310	
300	6	440	327.5	22	44	355	10
	10	445		26	46	350	
	16	460		28	46	350	
	25	485		34	67	364	
350	40	515	359.5	42	67	380	10
	10	505		26	53	400	
	16	520		30	57	400	
	25	555		38	72	418	
400	40	580	411.0	46	72	424	10
	10	565		26	57	456	
	16	580		32	63	456	
	25	620		40	78	472	
450	40	660	462.0	50	78	478	12
	10	615		28	63	502	
	16	640		34	68	502	
	25	670		42	84	520	
500	40	685	513.5	50	84	522	12
	10	670		28	67	559	
	16	715		34	73	559	
	25	730		44	90	580	
600	40	755	616.5	52	90	576	12
	10	780		28	75	658	
	16	840		36	83	658	
	25	845		46	100	684	
	40	890		60	100	686	
-	-	-	-	-	-	-	-
-	-	-	-	-	-	-	-

Notes

- The hubs of slip on (code 112) flanges are parallel or have a draft <7 degrees.
- For drilling details see page 8-64.
- For tolerances see page 8-61.
- For facing types and dimensions see page 8-62.

Threaded Flanges (Code 113) - BS 4504

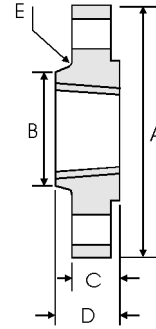
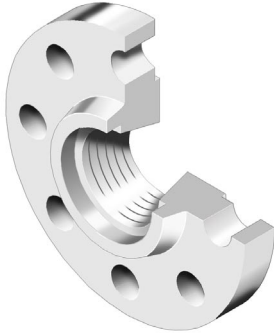

DN	PN	A mm	B mm	C mm	D mm	E mm
10	6	75	25	12	20	3
	16	90	30	14	20	
	40	90	30	16	22	
15	6	80	30	12	20	3
	16	95	35	14	20	
	40	95	35	16	22	
20	6	90	40	14	24	4
	16	105	45	16	24	
	40	105	45	18	26	
25	6	100	50	14	24	4
	16	115	52	16	24	
	40	115	52	18	28	
32	6	120	60	14	26	5
	16	140	60	16	26	
	40	140	60	18	30	
40	6	130	70	14	26	5
	16	150	70	16	26	
	40	150	70	18	32	
50	6	140	80	14	28	5
	16	165	84	18	28	
	40	165	84	20	34	
65	6	160	100	14	32	6
	16	185	104	18	32	
	40	185	104	22	38	
80	6	190	110	16	34	6
	16	200	118	20	34	
	40	200	118	24	40	
100	6	210	130	16	40	6
	16	220	140	20	40	
	40	235	145	24	44	

DN	PN	A mm	B mm	C mm	D mm	E mm
125	6	240	160	18	44	6
	16	250	168	22	44	
	40	270	170	26	48	
150	6	265	185	18	44	8
	16	285	195	22	44	
	40	300	200	28	52	
200	6	320	240	20	44	8
	16	340	246	24	44	
	40	375	260	34	52	
250	6	375	295	22	44	10
	16	405	298	26	46	
	40	450	312	38	60	
300	6	440	355	22	44	10
	16	460	350	28	46	
	40	515	380	42	67	
350	16	520	400	30	57	10
	40	580	424	46	72	
	16	580	456	32	63	
400	40	660	478	50	78	10
	16	640	502	34	68	
	40	685	522	50	84	
450	16	715	559	34	73	12
	40	755	576	52	90	
	16	840	658	36	83	
600	40	890	686	60	100	12
	16	910	760	36	83	
	16	1025	864	38	90	
800	16	1125	968	40	94	12
900	16	1255	1072	42	100	12
-	-	-	-	-	-	-

Notes

- Threaded flange (code 113) threads are tapered or parallel. BS 21 or ANSI/ASME B1.20.1 threads may be specified (see Section 10).
- The hubs of threaded (code 113) flanges are parallel or have a draft <7 degrees.
- For drilling details see page 8-64.
- For tolerances see page 8-61.
- For facing types and dimensions see page 8-62.

Blank Flanges (Code 105) - BS 4504

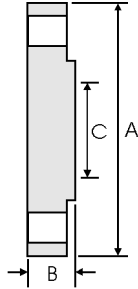
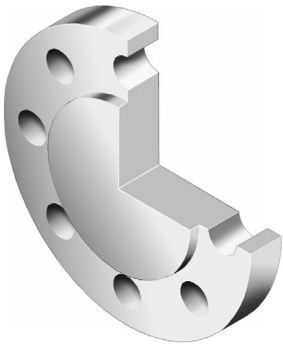

DN	PN	A mm	B mm	C mm
10	2.5 & 6	75	12	-
	10 & 16	90	14	-
	25 & 40	90	16	-
15	2.5 & 6	80	12	-
	10 & 16	95	14	-
	25 & 40	95	16	-
20	2.5 & 6	90	14	-
	10 & 16	105	16	-
	25 & 40	105	18	-
25	2.5 & 6	100	14	-
	10 & 16	115	16	-
	25 & 40	115	18	-
32	2.5 & 6	120	14	-
	10 & 16	140	16	-
	25 & 40	140	18	-
40	2.5 & 6	130	14	-
	10 & 16	150	16	-
	25 & 40	150	18	-
50	2.5 & 6	140	14	-
	10 & 16	165	18	-
	25 & 40	165	20	-
65	2.5 & 6	160	14	55
	10 & 16	185	18	55
	25 & 40	185	22	55
80	2.5 & 6	190	16	70
	10 & 16	200	20	70
	25 & 40	200	24	70
	2.5 & 6	210	16	90
100	10 & 16	220	20	90
	25 & 40	235	24	90
	2.5 & 6	240	18	115
	10 & 16	250	22	115
125	25 & 40	270	26	115
	2.5 & 6	265	18	140
	10 & 16	285	22	140
150	25 & 40	300	28	140
	2.5 & 6	320	20	190
	10 & 16	340	24	190
200	25	360	30	190
	40	375	34	190
	2.5 & 6	375	22	235
250	10	395	26	235
	16	405	26	235
	25	425	32	235
	40	450	38	235

DN	PN	A mm	B mm	C mm
300	2.5 & 6	440	22	285
	10	445	26	285
	16	460	28	285
	25	485	34	285
	40	515	42	285
350	2.5 & 6	490	22	325
	10	505	26	325
	16	520	30	325
	25	555	38	325
	40	580	46	325
400	2.5 & 6	540	22	375
	10	565	26	375
	16	580	32	375
	25	620	40	375
	40	660	50	375
450	2.5 & 6	595	24	425
	10	615	28	425
	16	640	34	425
	25	670	42	425
	40	685	54	425
500	2.5 & 6	645	24	475
	10	670	28	475
	16	715	36	475
	25	730	45	475
	40	755	56	475
600	2.5 & 6	755	34	575
	10	780	34	575
	16	840	44	575
	25	845	54	575
	40	890	70	575
700	2.5	860	36	-
	6	860	38	-
	10	895	38	670
	16	910	48	670
800	2.5	975	38	-
	6	975	42	-
	10	1015	42	770
	16	1025	52	770
900	2.5	1075	40	-
	6	1075	46	-
	10	1115	46	860
	16	1125	58	860
1000	2.5	1175	42	-
	6	1175	52	-
	10	1230	52	960
	16	1255	64	960
1200	2.5	1375	44	-
	6	1405	60	-
	10	1455	60	1160
	16	1485	76	1160
1400	2.5	1575	48	-
	6	1630	68	-
1600	2.5	1790	51	-
	6	1830	76	-
1800	2.5	1990	54	-
	6	2045	84	-
2000	2.5	2190	58	-
	6	2265	92	-

Notes

- Dimension B is the range thickness with or without a raised face.
- Dimension C is the maximum diameter of the centre portion of a blank flange face which need not be machined.
- For drilling details see page 8-64.
- For tolerances see page 8-61.
- For facing types and dimensions see page 8-62.

BS 10 : 1962

British Standard BS 10 : 1962 - Specification for Flanges and Bolting for Pipes, Valves, and Fittings. This covers plain, boss, integrally cast or forged, and welding neck type flanges, in ten tables. Although BS 10 is obsolescent, it remains in use for the dimensions of light duty, economy stainless steel flanges in applications where corrosion resistance and/or hygiene, rather than high pressures and temperatures, are the primary considerations. The following tables detail the applicable standard dimensions from Tables D, E, F and H of BS 10.

Flange Dimensions Based on Tables D and E of BS 10 : 1962

Common Flange Size Designation (Nominal Bore of Pipe)	BS 10 Table D Dimensions					BS 10 Table E Dimensions				
	Overall Diameter of Flange	Flange Thickness	Bolt Circle Diameter	Number of Bolts	Diameter of Bolts	Overall Diameter of Flange	Flange Thickness	Bolt Circle Diameter	Number of Bolts	Diameter of Bolts
	in	in	in		in	in	in	in		in
1/2	3 ³ / ₄	3 ¹ / ₁₆	2 ⁵ / ₈	4	1/2	3 ³ / ₄	1/4	2 ⁵ / ₈	4	1/2
3/4	4	3 ¹ / ₁₆	2 ⁷ / ₈	4	1/2	4	1/4	2 ⁷ / ₈	4	1/2
1	4 ¹ / ₂	3 ¹ / ₁₆	3 ¹ / ₄	4	1/2	4 ¹ / ₂	9/32	3 ¹ / ₄	4	1/2
1 ¹ / ₄	4 ³ / ₄	1/4	3 ⁷ / ₁₆	4	1/2	4 ³ / ₄	5 ¹ / ₁₆	3 ⁷ / ₁₆	4	1/2
1 ¹ / ₂	5 ¹ / ₄	1/4	3 ⁷ / ₈	4	1/2	5 ¹ / ₄	1 ¹ / ₃₂	3 ⁷ / ₈	4	1/2
2	6	5 ¹ / ₁₆	4 ¹ / ₂	4	5/8	6	3/8	4 ¹ / ₂	4	5/8
2 ¹ / ₂	6 ¹ / ₂	5 ¹ / ₁₆	5	4	5/8	6 ¹ / ₂	1 ³ / ₃₂	5	4	5/8
3	7 ¹ / ₄	3/8	5 ³ / ₄	4	5/8	7 ¹ / ₄	7/16	5 ³ / ₄	4	5/8
3 ¹ / ₂	8	3/8	6 ¹ / ₂	4	5/8	8	1 ⁵ / ₃₂	6 ¹ / ₂	8	5/8
4	8 ¹ / ₂	3/8	7	4	5/8	8 ¹ / ₂	1/2	7	8	5/8
5	10	1/2	8 ¹ / ₄	8	5/8	10	9/16	8 ¹ / ₄	8	5/8
6	11	1/2	9 ¹ / ₄	8	5/8	11	1 ¹ / ₁₆	9 ¹ / ₄	8	3/4
7	12	1/2	10 ¹ / ₄	8	5/8	12	3/4	10 ¹ / ₄	8	3/4
8	13 ¹ / ₄	1/2	11 ¹ / ₂	8	5/8	13 ¹ / ₄	3/4	11 ¹ / ₂	8	3/4
9	14 ¹ / ₂	5/8	12 ³ / ₄	8	5/8	14 ¹ / ₂	1 ³ / ₁₆	12 ³ / ₄	12	3/4
10	16	5/8	14	8	3/4	16	7/8	14	12	3/4
12	18	3/4	16	12	3/4	18	1	16	12	7/8
13	19 ¹ / ₄	3/4	17 ¹ / ₄	12	3/4	19 ¹ / ₄	1	17 ¹ / ₄	12	7/8
14	20 ³ / ₄	7/8	18 ¹ / ₂	12	7/8	20 ³ / ₄	1 ¹ / ₈	18 ¹ / ₂	12	7/8
15	21 ³ / ₄	7/8	19 ¹ / ₂	12	7/8	21 ³ / ₄	1 ¹ / ₄	19 ¹ / ₂	12	7/8
16	22 ³ / ₄	7/8	20 ¹ / ₂	12	7/8	22 ³ / ₄	1 ¹ / ₄	20 ¹ / ₂	12	7/8
17	24	1	21 ³ / ₄	12	7/8	24	1 ³ / ₈	21 ³ / ₄	12	7/8
18	25 ¹ / ₄	1	23	12	7/8	25 ¹ / ₄	1 ³ / ₈	23	16	7/8
19	26 ¹ / ₂	1	24	12	7/8	26 ¹ / ₂	1 ¹ / ₂	24	16	7/8
20	27 ³ / ₄	1 ¹ / ₈	25 ¹ / ₄	16	7/8	27 ³ / ₄	1 ¹ / ₂	25 ¹ / ₄	16	7/8
21	29	1 ¹ / ₈	26 ¹ / ₂	16	7/8	29	1 ⁵ / ₈	26 ¹ / ₂	16	1
22	30	1 ¹ / ₈	27 ¹ / ₂	16	1	30	1 ³ / ₄	27 ¹ / ₂	16	1
23	31	1 ¹ / ₈	28 ¹ / ₂	16	1	31	1 ³ / ₄	28 ¹ / ₂	16	1
24	32 ¹ / ₂	1 ¹ / ₄	29 ³ / ₄	16	1	32 ¹ / ₂	1 ⁷ / ₈	29 ³ / ₄	16	1 ¹ / ₈

Note

- Bolt hole diameters are as follows:

For 1/2 in and 5/8 in bolts, the bolt hole shall be 1/16 in larger than the bolt diameter.

For 3/4 in bolts and larger, the bolt hole shall be not more than 1/8 in larger than the bolt diameter.

BS 10 : 1962

Flange Dimensions Based on Tables F and H of BS 10 : 1962

Common Flange Size Designation (Nominal Bore of Pipe)	BS 10 Table F Dimensions					BS 10 Table H Dimensions				
	Overall Diameter of Flange	Flange Thickness	Bolt Circle Diameter	Number of Bolts	Diameter of Bolts	Overall Diameter of Flange	Flange Thickness	Bolt Circle Diameter	Number of Bolts	Diameter of Bolts
1/2	3 ³ / ₄	³ / ₈	2 ⁵ / ₈	4	1/2	4 ¹ / ₂	1/2	3 ¹ / ₄	4	⁵ / ₈
3/4	4	³ / ₈	2 ⁷ / ₈	4	1/2	4 ¹ / ₂	1/2	3 ¹ / ₄	4	⁵ / ₈
1	4 ³ / ₄	³ / ₈	3 ⁷ / ₁₆	4	⁵ / ₈	4 ³ / ₄	⁹ / ₁₆	3 ⁷ / ₁₆	4	⁵ / ₈
1 ¹ / ₄	5 ¹ / ₄	1/2	3 ⁷ / ₈	4	⁵ / ₈	5 ¹ / ₄	¹¹ / ₁₆	3 ⁷ / ₈	4	⁵ / ₈
1 ¹ / ₂	5 ¹ / ₂	1/2	4 ¹ / ₈	4	⁵ / ₈	5 ¹ / ₂	¹¹ / ₁₆	4 ¹ / ₈	4	⁵ / ₈
2	6 ¹ / ₂	⁵ / ₈	5	4	⁵ / ₈	6 ¹ / ₂	³ / ₄	5	4	⁵ / ₈
2 ¹ / ₂	7 ¹ / ₄	⁵ / ₈	5 ³ / ₄	8	⁵ / ₈	7 ¹ / ₄	³ / ₄	5 ³ / ₄	8	⁵ / ₈
3	8	⁵ / ₈	6 ¹ / ₂	8	⁵ / ₈	8	⁷ / ₈	6 ¹ / ₂	8	⁵ / ₈
3 ¹ / ₂	8 ¹ / ₂	³ / ₄	7	8	⁵ / ₈	8 ¹ / ₂	⁷ / ₈	7	8	⁵ / ₈
4	9	³ / ₄	7 ¹ / ₂	8	⁵ / ₈	9	1	7 ¹ / ₂	8	⁵ / ₈
5	11	⁷ / ₈	9 ¹ / ₄	8	³ / ₄	11	1 ¹ / ₈	9 ¹ / ₄	8	³ / ₄
6	12	⁷ / ₈	10 ¹ / ₄	12	³ / ₄	12	1 ¹ / ₈	10 ¹ / ₄	12	³ / ₄
7	13 ¹ / ₄	⁷ / ₈	11 ¹ / ₂	12	³ / ₄	13 ¹ / ₄	1 ¹ / ₄	11 ¹ / ₂	12	³ / ₄
8	14 ¹ / ₂	1	12 ³ / ₄	12	³ / ₄	14 ¹ / ₂	1 ¹ / ₄	12 ³ / ₄	12	³ / ₄
9	16	1 ¹ / ₈	14	12	⁷ / ₈	16	1 ³ / ₈	14	12	⁷ / ₈
10	17	1 ¹ / ₈	15	12	⁷ / ₈	17	1 ³ / ₈	15	12	⁷ / ₈
12	19 ¹ / ₄	1 ¹ / ₄	17 ¹ / ₄	16	⁷ / ₈	19 ¹ / ₄	1 ⁵ / ₈	17 ¹ / ₄	16	⁷ / ₈
13	20 ³ / ₄	1 ³ / ₈	18 ¹ / ₂	16	1	20 ³ / ₄	1 ³ / ₄	18 ¹ / ₂	16	1
14	21 ³ / ₄	1 ³ / ₈	19 ¹ / ₂	16	1	21 ³ / ₄	1 ⁷ / ₈	19 ¹ / ₂	16	1
15	22 ³ / ₄	1 ¹ / ₂	20 ¹ / ₂	16	1	22 ³ / ₄	2	20 ¹ / ₂	16	1
16	24	1 ⁵ / ₈	21 ³ / ₄	20	1	24	2 ¹ / ₈	21 ³ / ₄	20	1
17	25 ¹ / ₄	1 ³ / ₄	23	20	1	25 ¹ / ₄	2 ¹ / ₄	23	20	1
18	26 ¹ / ₂	1 ³ / ₄	24	20	1 ¹ / ₈	26 ¹ / ₂	2 ³ / ₈	24	20	1 ¹ / ₈
19	27 ³ / ₄	1 ³ / ₄	25 ¹ / ₄	20	1 ¹ / ₈	27 ³ / ₄	2 ¹ / ₂	25 ¹ / ₄	20	1 ¹ / ₈
20	29	2	26 ¹ / ₂	24	1 ¹ / ₈	29	2 ⁵ / ₈	26 ¹ / ₂	24	1 ¹ / ₈
21	30	2	27 ¹ / ₂	24	1 ¹ / ₈	30	2 ³ / ₄	27 ¹ / ₂	24	1 ¹ / ₈
22	31	2 ¹ / ₈	28 ¹ / ₂	24	1 ¹ / ₈	31	2 ³ / ₄	28 ¹ / ₂	24	1 ¹ / ₈
23	32 ¹ / ₂	2 ¹ / ₄	29 ³ / ₄	24	1 ¹ / ₄	32 ¹ / ₂	3	29 ³ / ₄	24	1 ¹ / ₄
24	33 ¹ / ₂	2 ¹ / ₄	30 ³ / ₄	24	1 ¹ / ₄	33 ¹ / ₂	3	30 ³ / ₄	24	1 ¹ / ₄

Note

- Bolt hole diameters are as follows:

For ¹/₂ in and ⁵/₈ in bolts, the bolt hole shall be ¹/₁₆ in larger than the bolt diameter.

For ³/₄ in bolts and larger, the bolt hole shall be not more than ¹/₈ in larger than the bolt diameter.

Pressure/Temperature Ratings

The following tables (based on ANSI B16.5-1996 and B16.47-1996) provide pressure/temperature ratings for stainless steel materials used for flanges. Refer to Section 4 for further details regarding ASTM A 182. Also, the chemical analyses of ASTM A 240 grades are included in Section 1.

Materials: 304, 304H

Nominal Designation	Forgings	Plates
18Cr-8Ni	A 182 Gr. F304 ¹ A 182 Gr. F304H	A 240 Gr. 304 ¹ A 240 Gr. 304H

Note

¹ At temperatures over 1000°F, use only when the carbon content is 0.04% or higher.

Pressure/temperature ratings

Temperature		Working Pressures by Classes, psig						
°F	°C	150 lb	300 lb	400 lb	600 lb	900 lb	1500 lb	2500 lb
-20 to 100	-29 to 37.8	275	720	960	1440	2160	3600	6000
300	149	205	540	720	1080	1620	2700	4500
500	260	170	465	620	930	1395	2330	3880
700	371	110	425	565	850	1275	2125	3540
850	454	65	395	530	790	1190	1980	3300
1000	538	20	320	430	640	965	1605	2675
1150	566	-	200	265	400	595	995	1655
1300	704	-	85	115	170	255	430	715
1400	760	-	50	65	95	145	240	400
1500	816	-	25	35	55	80	135	230

Note

- psig = pounds per square inch gauge (0 psig = 14.7 psi absolute)

Materials: 316, 316H, 317

Nominal Designation	Forgings	Plates
16Cr-12Ni-2Mo	A 182 Gr. F316 ¹ A 182 Gr. F316H	A 240 Gr. 316 ¹ A 240 Gr. 316H
18Cr-13Ni-3Mo	-	A 240 Gr. 317 ¹

Note

¹ At temperatures over 1000°F, use only when the carbon content is 0.04% or higher.

Pressure/temperature ratings

Temperature		Working Pressures by Classes, psig						
°F	°C	150 lb	300 lb	400 lb	600 lb	900 lb	1500 lb	2500 lb
-20 to 100	-29 to 37.8	275	720	960	1440	2160	3600	6000
300	149	215	560	745	1120	1680	2795	4660
500	260	170	480	635	955	1435	2390	3980
700	371	110	430	580	870	1305	2170	3620
850	454	65	420	555	835	1255	2090	3480
1000	538	20	350	465	700	1050	1750	2915
1150	566	-	235	315	475	710	1185	1970
1300	704	-	115	155	235	350	585	970
1400	760	-	75	100	150	225	380	630
1500	816	-	40	55	85	125	205	345

Note

- psig = pounds per square inch gauge (0 psig = 14.7 psi absolute)

Pressure/Temperature Ratings

Materials: 316L, 304L

Nominal Designation	Forgings	Plates
16Cr-12Ni-2Mo 18Cr-8Ni	A 182 Gr. F316L A 182 Gr. F304L ¹	A 240 Gr. 316L A 240 Gr. 304L ¹

Note

1 Not to be used over 800°F.

Pressure/temperature ratings

Temperature		Working Pressures by Classes, psig						
°F	°C	150 lb	300 lb	400 lb	600 lb	900 lb	1500 lb	2500 lb
-20 to 100	-29 to 37.8	230	600	800	1200	1800	3000	5000
300	149	175	455	605	910	1360	2270	3780
500	260	145	380	510	765	1145	1910	3180
700	371	110	345	460	685	1030	1715	2860
850	454	65	320	430	645	965	1610	2680

Note

- psig = pounds per square inch gauge (0 psig = 14.7 psi absolute)

Materials: 321, 321H

Nominal Designation	Forgings	Plates
18Cr-10Ni-Ti	A 182 Gr. F321 ² A 182 Gr. F321H ¹	A 240 Gr. 321 ² A 240 Gr. 321H ¹

Notes

1 At temperatures over 1000°F, use only if the material is heat treated by heating to a minimum temperature of 2000°F.

2 Not to be used over 1000°F.

Pressure/temperature ratings

Temperature		Working Pressures by Classes, psig						
°F	°C	150 lb	300 lb	400 lb	600 lb	900 lb	1500 lb	2500 lb
-20 to 100	-29 to 37.8	275	720	960	1440	2160	3600	6000
300	149	230	595	795	1190	1785	2975	4960
500	260	170	515	685	1030	1545	2570	4285
700	371	110	465	620	930	1395	2330	3880
850	454	65	445	595	895	1340	2230	3720
1000	538	20	355	475	715	1070	1785	2970
1150	566	-	235	315	465	710	1185	1970
1300	704	-	110	145	220	330	550	915
1400	760	-	65	85	130	195	325	545
1500	816	-	40	50	75	115	190	315

Note

- psig = pounds per square inch gauge (0 psig = 14.7 psi absolute)

Pressure/Temperature Ratings

Materials: 347, 347H, 348, 348H

Nominal Designation	Forgings	Plates
18Cr-10Ni-Cb	A 182 Gr. F347 ² A 182 Gr. F347H ¹ A 182 Gr. F348 ² A 182 Gr. F348H ¹	A 240 Gr. 347 ² A 240 Gr. 347H ¹ A 240 Gr. 348 ² A 240 Gr. 348H ¹

Notes

- At temperatures over 1000°F, use only if the material is heat treated by heating to a minimum temperature of 2000°F.
- Not to be used over 1000°F.

Pressure/temperature ratings

Temperature		Working Pressures by Classes, psig						
°F	°C	150 lb	300 lb	400 lb	600 lb	900 lb	1500 lb	2500 lb
-20 to 100	-29 to 37.8	275	720	960	1440	2160	3600	6000
300	149	230	615	820	1230	1845	3070	5120
500	260	170	540	720	1080	1620	2700	4500
700	371	110	495	660	990	1485	2470	4120
850	454	65	485	645	970	1455	2425	4040
1000	538	20	365	485	725	1090	1820	3030
1150	566	-	275	365	550	825	1370	2285
1300	704	-	95	125	185	280	465	770
1400	760	-	55	75	110	165	275	455
1500	816	-	35	45	70	105	170	285

Note

- psig = pounds per square inch gauge (0 psig = 14.7 psi absolute)

Materials: 309S, 309H

Nominal Designation	Forgings	Plates
23Cr-12Ni	-	A 240 Gr. 309S ^{1,2,3} A 240 Gr. 309H

Notes

- At temperatures over 1000°F, use only when the carbon content is 0.04% or higher.
- For temperatures above 1000°F, use only if the material solution is heat treated to the minimum temperature specified in the specification but not lower than 1900°F, and quenching in water or rapidly cooling by other means.
- This material should be used for service temperatures 1050°F and above only when assurance is provided that grain size is not finer than ASTM 6.

Pressure/temperature ratings

Temperature		Working Pressures by Classes, psig						
°F	°C	150 lb	300 lb	400 lb	600 lb	900 lb	1500 lb	2500 lb
-20 to 100	-29 to 37.8	260	670	895	1345	2015	3360	5600
300	149	220	570	760	1140	1705	2875	4740
500	260	170	505	670	1010	1510	2520	4200
700	371	110	455	610	910	1370	2280	3800
850	454	65	425	565	850	1275	2125	3540
1000	538	20	335	450	670	1010	1680	2800
1150	566	-	170	230	345	515	860	1430
1300	704	-	80	105	160	235	395	660
1400	760	-	45	60	90	135	225	370
1500	816	-	25	30	50	70	120	200

Note

- psig = pounds per square inch gauge (0 psig = 14.7 psi absolute)

Pressure/Temperature Ratings

Materials: 310, 310S, 310H

Nominal Designation	Forgings	Plates
25Cr-20Ni	A 182 Gr. F310 ^{1,3}	A 240 Gr. 310S ^{1,2,3} A 240 Gr. 310H

Notes

- 1 At temperatures over 1000°F, use only when the carbon content is 0.04% or higher.
- 2 For temperatures above 1000°F, use only if the material is heat treated by heating it to a temperature of at least 1900°F and quenching in water or rapidly cooling by other means.
- 3 Service temperatures of 1050°F and above should only be used when assurance is provided that grain size is not finer than ASTM 6.

Pressure/temperature ratings

Temperature		Working Pressures by Classes, psig						
°F	°C	150 lb	300 lb	400 lb	600 lb	900 lb	1500 lb	2500 lb
-20 to 100	-29 to 37.8	260	670	895	1345	2015	3360	5600
300	149	220	570	760	1140	1705	2845	4740
500	260	170	505	675	1015	1520	2530	4220
700	371	110	455	610	910	1370	2280	3800
850	454	65	425	575	855	1280	2135	3560
1000	538	20	345	460	685	1030	1720	2865
1150	566	-	190	250	375	565	945	1570
1300	704	-	75	100	150	225	375	630
1400	760	-	45	60	90	135	225	370
1500	816	-	25	35	50	75	130	215

Note

- psig = pounds per square inch gauge (0 psig = 14.7 psi absolute)

Materials: F44, F51, F53

Nominal Designation	Forgings	Plates
20Cr-18Ni-6Mo	A 182 Gr. F44	A 240 Gr. S31254
22Cr-5Ni-3Mo-N	A 182 Gr. F51 ¹	A 240 Gr. S31803 ¹
25Cr-7Ni-4Mo-N	A 182 Gr. F53 ¹	A 240 Gr. S32750 ¹

Note

- 1 This steel may become brittle after service at moderately elevated temperatures. Not to be used over 600°F.

Pressure/temperature ratings

Temperature		Working Pressures by Classes, psig						
°F	°C	150 lb	300 lb	400 lb	600 lb	900 lb	1500 lb	2500 lb
-20 to 100	-29 to 37.8	290	750	1000	1500	2250	3750	6250
300	149	230	665	885	1330	1995	3325	5540
500	260	170	575	770	1150	1730	2880	4800
700	371	110	540	725	1085	1625	2710	4520
750	399	95	530	710	1065	1595	2660	4430

Note

- psig = pounds per square inch gauge (0 psig = 14.7 psi absolute)